



Automation for a Changing World

# Delta Sensorless Vector Control Compact Drive VFD-EL Series



[www.deltaww.com](http://www.deltaww.com)

 **DELTA**  
Smarter. Greener. Together.

## Features

### ▶ Standard Modbus Protocol

Standard Modbus protocol via RS-485

### ▶ Built-in EMC Filter (230V single-phase and 460V 3-phase)

The built-in EMC filter reduces electromagnetic interference and complies with the EN61800-3 standard

### ▶ Compact Design

Space saving and easy DIN rail mounting with optional DIN rail adapter (Built-in for Frame B)

### ▶ Optional Fieldbus Modules

Provide connection to a variety of networks, including PROFIBUS, DeviceNet and CANopen

### ▶ RFI Switch for IT Mains

Removable "Y" capacitor to use with IT mains supplies



### ▶ DC Bus Sharing

Multiple VFD-EL can be connected in parallel to share the regenerative braking energy. This prevents over-voltage and stabilizes DC bus voltage.

\*This function is not supported by the 115V model.

### ▶ Complete Protection Functions

High precision current detection, full overload protection (oL, oL1 and oL2), overvoltage/overcurrent stall prevention, short-circuit protection, reset after fault, speed search function and motor overheat protection by PTC

### ▶ Power Range

Single-phase 115V series: 0.2~0.75kW (0.25~1 hp)

Single-phase 230V series: 0.2~2.2kW (0.25~3 hp)

3-phase 230V series: 0.2~3.7kW (0.25~5 hp)

3-phase 460V series: 0.4~3.7kW (0.50~5 hp)

### ▶ Side-by-side Installation (40°C)

High-efficiency cooling and flexible spacing



### ▶ Easy Maintenance

Removable cooling fan for easy maintenance



## ► Applications

### ► Conveyor Belts

1. Multi-step speed application: provides multi-step speed settings to meet the needs of a conveyor belt
2. Side-by-side installation to save space
3. DC bus sharing: connects multiple drives in parallel to share the regenerative energy and prevent overvoltage



### ► Winders

Auto acceleration/deceleration function provides rapid start/stop of operation and increases productivity and efficiency

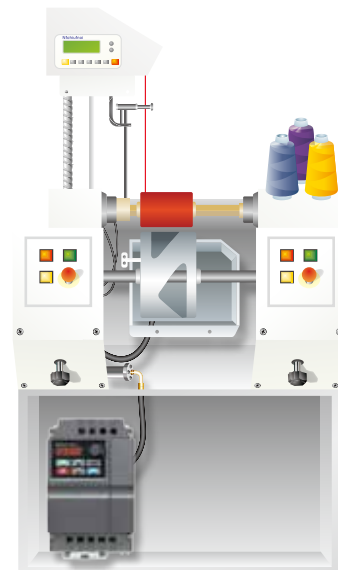

### ► Constant Pressure Control of Water Pumps

1. Built-in smart PID controller saves the cost of a specified external PID meter
2. Built-in auto detection of water suspension and auto power-on saves the cost of external PLC controller and relay
3. A wide range of input voltages are available, including single-phase 110V/230V and 3-phase 230V/460V, for various pump applications and different countries

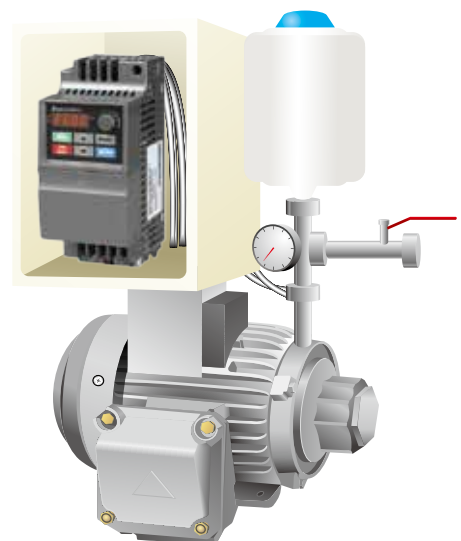

# Standard Wiring Diagram

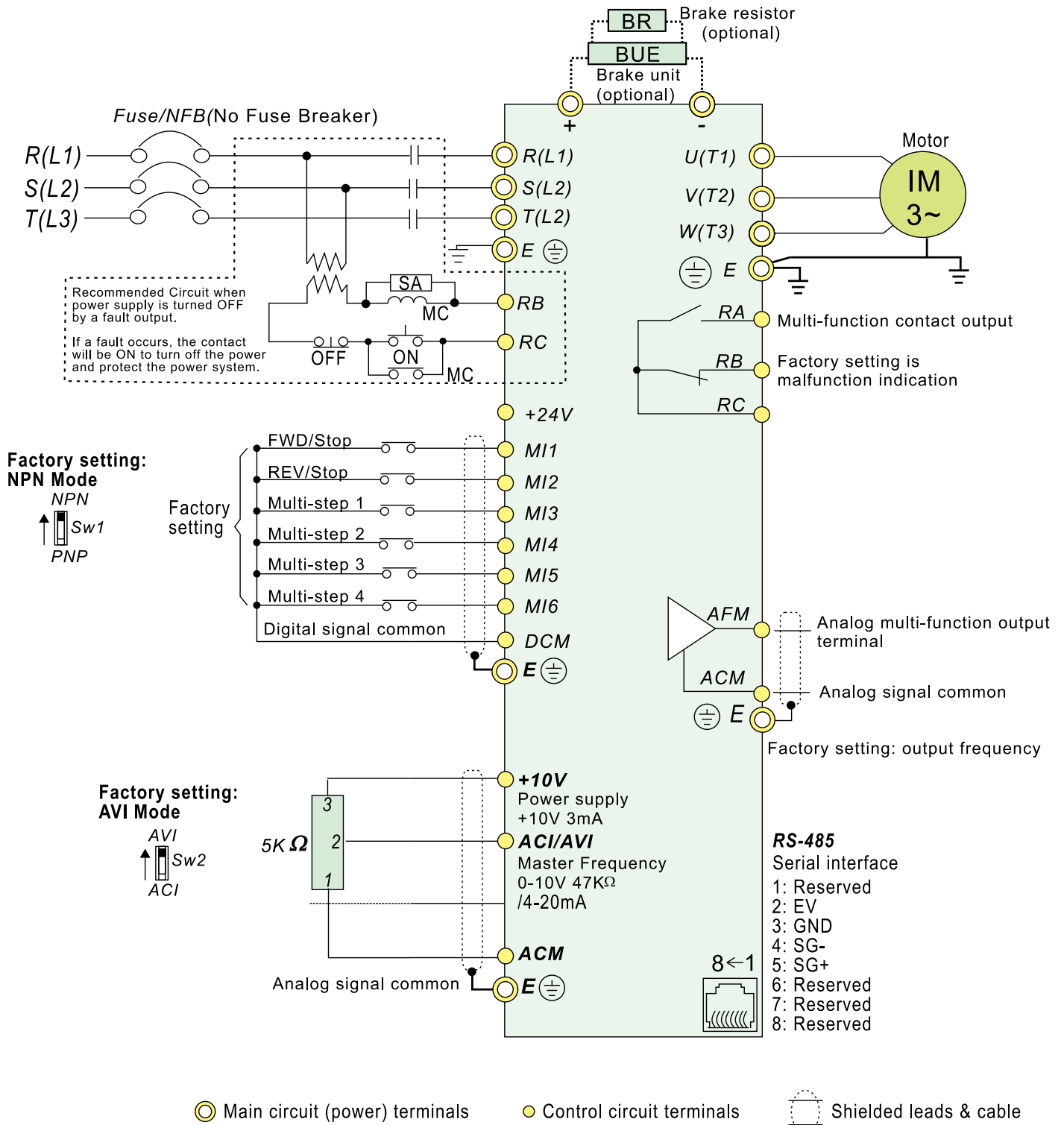

**NOTE**

It is recommended to install circuit breaker at the control terminal to protect the circuit from operation abnormality or sudden power outage.

The protection circuit uses the multi-function output terminal of the AC motor drive for connection. When an abnormal condition (closed contact) occurs, the external power supply is disconnected to protect the power system of the AC motor drive.

## External Parts

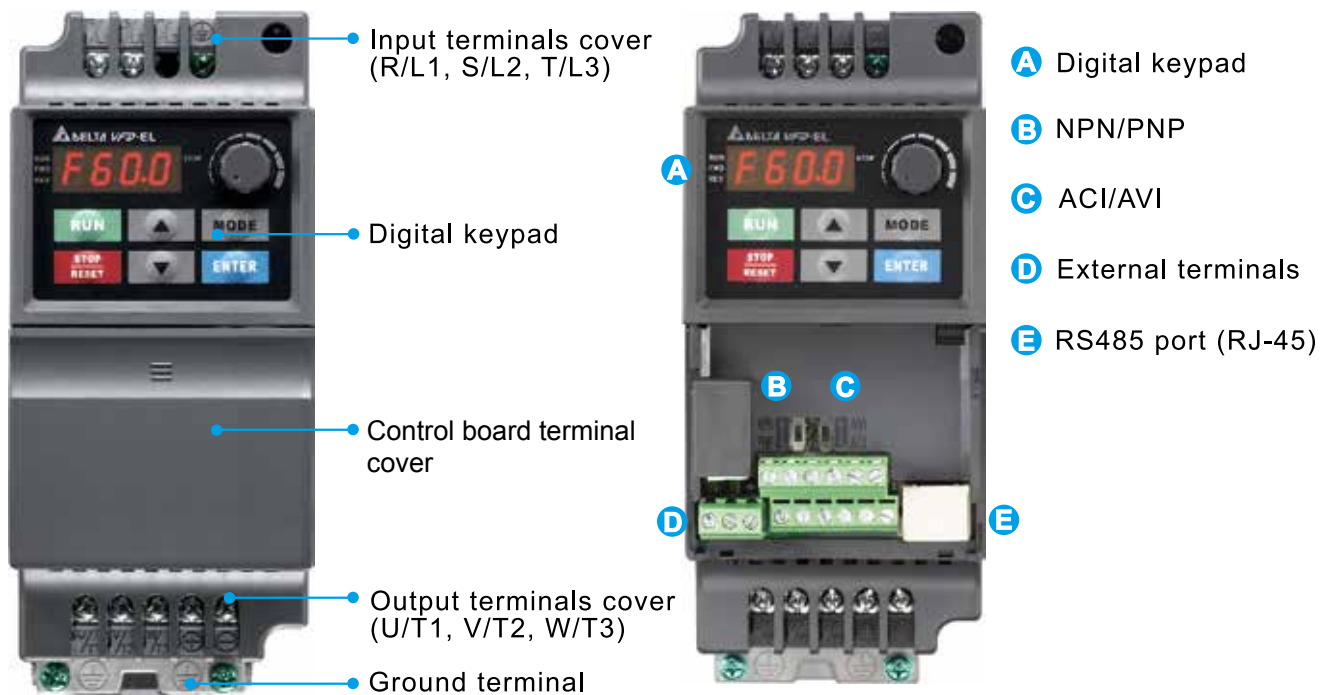

## Control Terminals

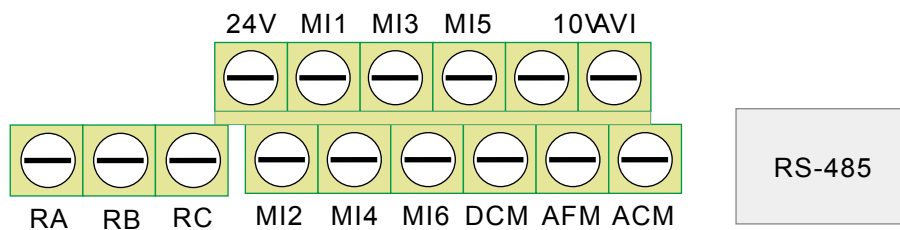

## Model Explanation

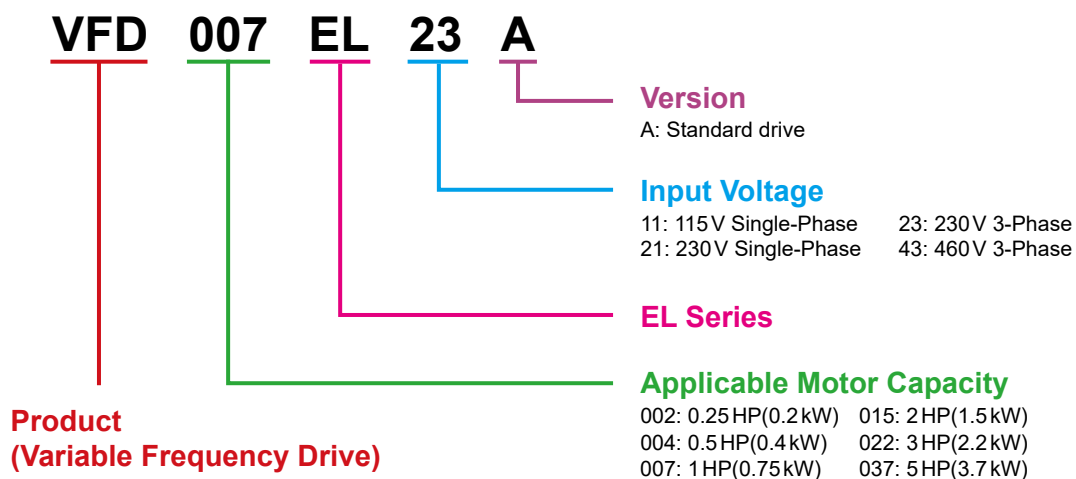

## Application Fields

### Conveyor and Transportation Machinery

- Conveyor belt
- Automatic door
- Roller door
- Small elevator
- Escalator
- X,Y-axis traveling crane

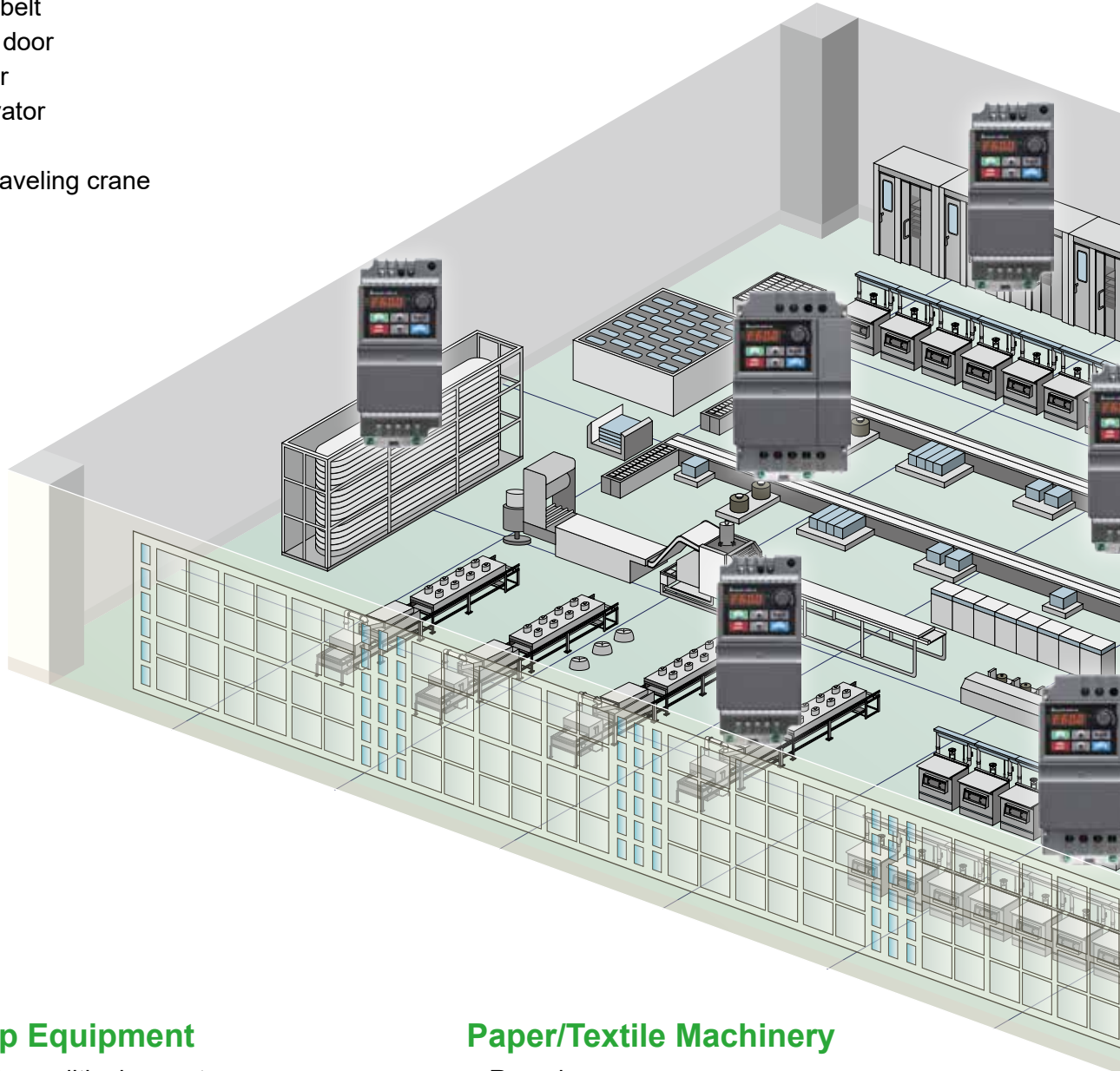

### Fan/Pump Equipment

- Building air conditioning system
- Wastewater processing system
- Constant pressure water treatment system
- Water treatment pump
- Agricultural pump
- Temperature control of mid and larger oven
- Air compressor
- Heat exchange fan
- Building water dispenser system
- Dryer's windmill

### Paper/Textile Machinery

- Round weaver
- Cross weaver
- Ribbon weaver
- Printing press
- Industrial sewing machine
- Knitting machine

## Food Processing

- Dumpling making machine
- Food mixer
- Noodle making machine

## Wood Working Machinery

- 4 side planer
- Wood carving machine
- Woodworking machine
- Simple cutting machine for wood working
- Spraying machine

## Machine Tool/Metal Processing Machinery

- Grinding machine
- Drilling machine
- Small lathe
- Milling machine
- Injection molding (clamp)

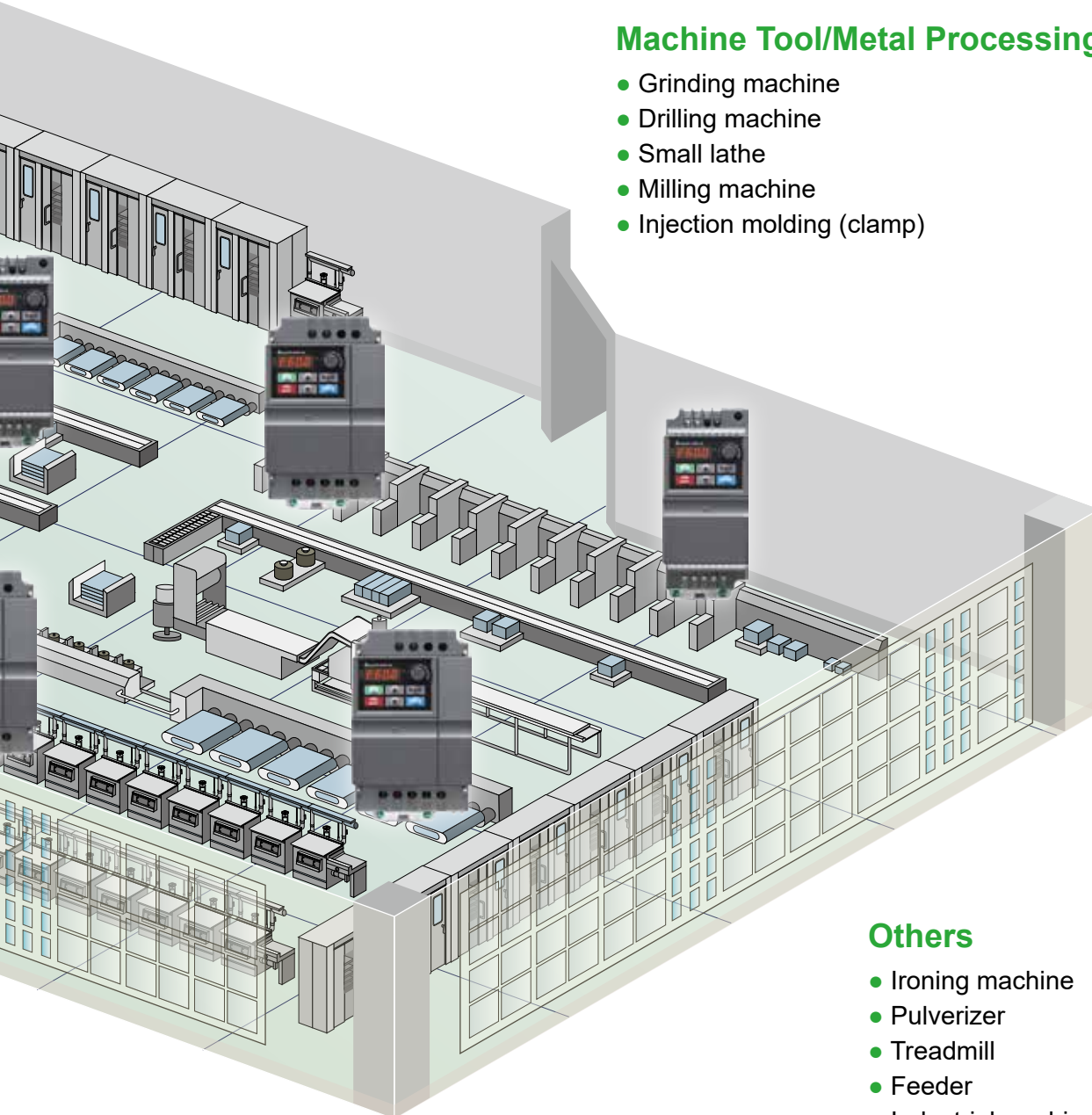

## Others



- Ironing machine
- Pulverizer
- Treadmill
- Feeder
- Industrial washing machine
- Car washing machine
- Packing machine
- Centrifuge
- Liquid mixing machine

# Specifications

115V	<b>Voltage Class</b>	115V		
	<b>Model Number VFD-___ EL</b>	002	004	007
	<b>Max. Applicable Motor Output (kW)</b>	0.2	0.4	0.75
	<b>Max. Applicable Motor Output (Hp)</b>	0.25	0.5	1.0
Output Rating	<b>Rated Output Capacity (kVA)</b>	0.6	1.0	1.6
	<b>Rated Output Current (A)</b>	1.6	2.5	4.2
	<b>Maximum Output Voltage (V)</b>	3-phase proportional to twice the input voltage		
	<b>Output Frequency (Hz)</b>	0.1~599Hz		
	<b>Carrier Frequency (kHz)</b>	2~12		
Input Rating	<b>Rated Input Current (A)</b>	Single-phase		
		6.4	9	18
	<b>Rated Voltage/Frequency</b>	Single-phase 100~120V, 50/60Hz		
	<b>Voltage Tolerance</b>	±10% (90~132V)		
	<b>Frequency Tolerance</b>	±5% (47~63Hz)		
	<b>Cooling Method</b>	Natural cooling		
	<b>Weight (kg)</b>	1.1	1.1	1.4

230V	<b>Voltage Class</b>	230V					
	<b>Model Number VFD-___ EL</b>	002	004	007	015	022	037
	<b>Max. Applicable Motor Output (kW)</b>	0.2	0.4	0.75	1.5	2.2	3.7
	<b>Max. Applicable Motor Output (Hp)</b>	0.25	0.5	1.0	2.0	3.0	5.0
Output Rating	<b>Rated Output Capacity (kVA)</b>	0.6	1.0	1.6	2.9	4.2	6.5
	<b>Rated Output Current (A)</b>	1.6	2.5	4.2	7.5	11.0	17.0
	<b>Maximum Output Voltage (V)</b>	3-phase proportional to input voltage					
	<b>Output Frequency (Hz)</b>	0.1~599Hz					
	<b>Carrier Frequency (kHz)</b>	2~12					
Input Rating	<b>Rated Input Current (A)</b>	4.9	6.5	9.5	15.7	24	--
	<b>L21A</b>	Single-phase, 200~240V, 50/60Hz					
	<b>Rated Input Current (A)</b>	1.9	2.7	4.9	9	15	20.6
	<b>L23A</b>	Single-phase/3-phase, 200~240V, 50/60Hz					
	<b>Voltage Tolerance</b>	±10% (180~264V)					
	<b>Frequency Tolerance</b>	±5% (47~63Hz)					
	<b>Cooling Method</b>	Natural cooling	Fan cooling (XXXEL21A) Natural cooling (XXXEL23A)		Fan cooling		
	<b>Weight (kg)</b>	1.2	1.2	1.2	1.7	1.7	1.7

460V	<b>Voltage Class</b>	460V				
	<b>Model Number VFD-___ EL</b>	004	007	015	022	037
	<b>Max. Applicable Motor Output (kW)</b>	0.4	0.75	1.5	2.2	3.7
	<b>Max. Applicable Motor Output (hp)</b>	0.5	1.0	2.0	3.0	5.0
Output Rating	<b>Rated Output Capacity (kVA)</b>	1.2	2.0	3.3	4.4	6.8
	<b>Rated Output Current (A)</b>	1.5	2.5	4.2	5.5	8.2
	<b>Maximum Output Voltage (V)</b>	3-phase proportional to input voltage				
	<b>Output Frequency (Hz)</b>	0.1~599 Hz				
	<b>Carrier Frequency (kHz)</b>	2~12				
Input Rating	<b>Rated Input Current (A)</b>	3-phase				
		1.8	3.2	4.3	7.1	9.0
	<b>Rated Voltage/Frequency</b>	3-phase, 380~480V, 50/60Hz				
	<b>Voltage Tolerance</b>	±10% (342~528V)				
	<b>Frequency Tolerance</b>	±5% (47~63Hz)				
	<b>Cooling Method</b>	Natural cooling		Fan cooling		
	<b>Weight (kg)</b>	1.2	1.2	1.2	1.7	1.7

Control Characteristics	<b>Control System</b>		SPWM (Sinusoidal Pulse Width Modulation) control (V/F control)
	<b>Frequency Setting Resolution</b>		0.01 Hz
	<b>Output Frequency Resolution</b>		0.01 Hz
	<b>Torque Characteristics</b>		Including the auto-torque/auto-slip compensation; starting torque can be 150 % at 5.0 Hz
	<b>Overload Endurance</b>		150 % of rated current for 1 minute
	<b>Skip Frequency</b>		Three zones, setting range 0.1 ~ 599 Hz
	<b>Accel/Decel Time</b>		0.1 to 600 seconds (2 Independent settings for Accel/Decel time)
	<b>Stall Prevention Level</b>		Setting 20 to 250 % of rated current
	<b>DC Braking</b>		Operation frequency 0.1 ~ 599 Hz, output 0 ~ 100 % rated current Start time 0 ~ 60 seconds, stop time 0 ~ 60 seconds
	<b>Regenerated Braking Torque</b>		Approx. 20 % (up to 125 % possible with optional brake resistor)
	<b>V/F Pattern</b>		Adjustable V/F pattern
Operating Characteristics	<b>Frequency Setting</b>	<b>Keypad</b>	Setting by ▲ ▼
		<b>External Signal</b>	Potentiometer 5k/0.5W, 0 to +10 V <sub>DC</sub> , 4 to 20 mA, RS-485 interface; Multi-function Inputs 3 to 6 (15 steps, Jog, up/down)
	<b>Operation Setting Signal</b>	<b>Keypad</b>	Set by RUN and STOP
		<b>External Signal</b>	2 wires/3 wires (MI1, MI2, MI3), JOG operation, RS-485 serial interface (Modbus)
	<b>Multi-function Input Signal</b>		Multi-step selection 0 to 15, Jog, accel / decel inhibit, 2 accel / decel switches, counter, external Base Block, ACI/AVI selections, driver reset, UP/DOWN key settings, NPN/PNP input selection
	<b>Multi-function Output Indication</b>		AC drive operating, frequency attained, counter attained, zero speed, Base Block, fault indication, overheat alarm, emergency stop and status selections of input terminals
	<b>Analog Output Signal</b>		Output frequency / current
<b>Alarm Output Contact</b>		Contact will be ON when drive malfunctions (1 Form C/change-over contact or 1 open collector output)	
<b>Operation Functions</b>		AVR, accel / decel S-Curve, overvoltage / overcurrent stall prevention, 5 fault records, reverse inhibition, momentary power loss restart, DC braking, auto torque / slip compensation, adjustable carrier frequency, output frequency limits, parameter lock / reset, PID control, external counter, MODBUS communication, abnormal reset, abnormal re-start, power-saving, fan control, sleep/wake frequency, 1st/2nd frequency source selections, 1st/2nd frequency source combination, NPN/PNP selection	
<b>Protection Functions</b>		Over voltage, over current, under voltage, external fault, overload, ground fault, overheating, electronic thermal, IGBT short circuit, PTC	
<b>Display Keypad</b>		6-key, 7-segment LED with 4-digit, 4 status LEDs, master frequency, output frequency, output current, custom units, parameter values for setup and lock, faults, RUN, STOP, RESET, FWD/REV	
<b>Built-in EMC Filter</b>		For 230V 1-phase and 460V 3-phase models	
Environmental Conditions	<b>Enclosure Rating</b>		IP20
	<b>Pollution Degree</b>		2
	<b>Installation Location</b>		Altitude 1,000 m or lower, keep from corrosive gasses, liquid and dust
	<b>Ambient Temperature</b>		-10 °C ~ 50 °C (40 °C for side-by-side mounting) Non-Condensing and not frozen
	<b>Storage/ Transportation Temperature</b>		-20 °C ~ 60 °C
	<b>Ambient Humidity</b>		Below 90 % RH (non-condensing)
	<b>Vibration</b>		9.80665 m/s <sup>2</sup> (1G) less than 20 Hz, 5.88 m/s (0.6 G) at 20 ~ 50 Hz
<b>Certifications</b>		  	

# Dimensions

## Frame A

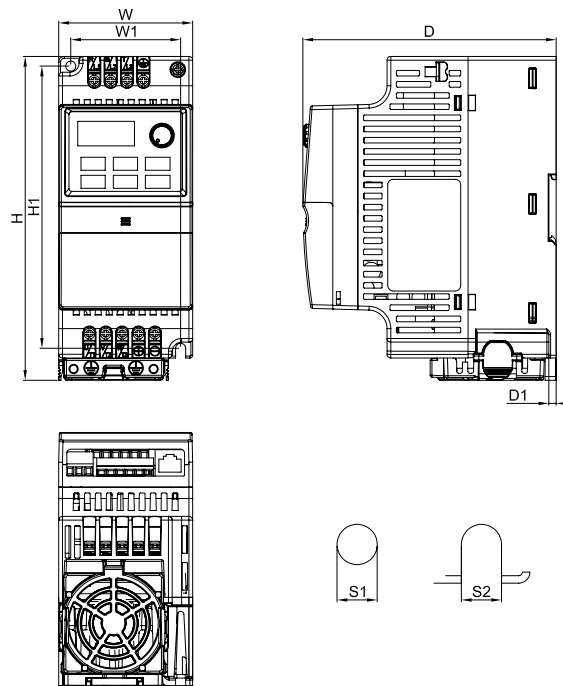

### MODEL

- VFD002EL11A
- VFD002EL21A
- VFD002EL23A
- VFD004EL11A
- VFD004EL21A
- VFD004EL23A
- VDF004EL43A
- VFD007EL21A
- VDF007EL23A
- VDF007EL43A
- VDF015EL23A
- VDF015EL43A

Unit: mm[inch]

Frame		W	H	D	W1	H1	D1	S1	S2
A	mm	72.0	174.0	136.0	59.0	151.6	4.0	5.4	5.4
	inch	2.83	6.86	5.36	2.32	5.97	0.16	0.21	0.21

## Frame B

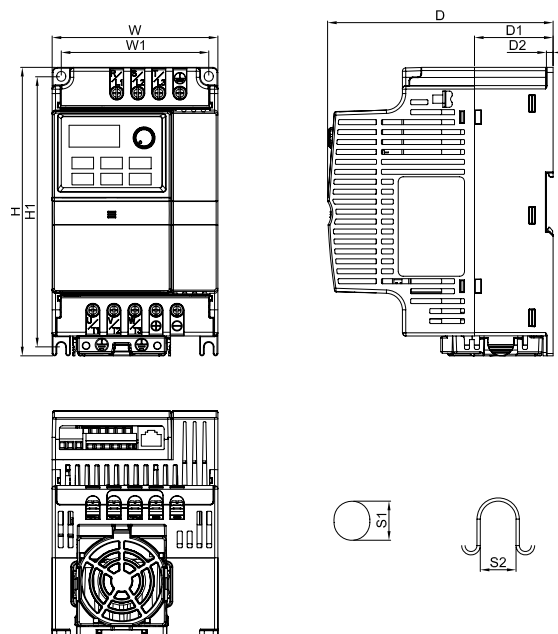

### MODEL

- VFD007EL11A
- VFD015EL21A
- VFD022EL21A
- VDF022EL23A
- VFD022EL43A
- VDF037EL23A
- VDF037EL43A

Unit: mm[inch]

Frame		W	H	D	W1	H1	D1	D2	S1	S2
B	mm	100.0	174.0	136.0	89.0	162.9	47.4	4.0	5.9	5.4
	inch	3.94	6.85	5.36	3.50	6.42	1.87	0.16	0.23	0.21

## Accessories

### Fieldbus Modules



▪ **DeviceNet**  
CME-DN01



▪ **PROFIBUS**  
CME-PD01



▪ **CANopen**  
CME-COP01

### Others



▪ **Brake unit**  
BUE-20015 BUE-40015  
BUE-20037 BUE-40037



▪ **Communication keypad**  
VFD-PU06



▪ **DIN Rail (Width 35mm)**  
MKEL-DRA MKEL-DRB



▪ **Brake resistor**





▪ **Zero phase reactor**  
RF220X00A



▪ **Grounding plate**  
MKE-EP

## Ordering Information

Frame Size	Power Range	Models
<b>Frame A</b> 	115V: 0.2 kW~0.4 kW 230V: 0.2 kW~1.5 kW 460V: 0.4 kW~1.5 kW	VFD002EL 11A / 21A / 23A VFD004EL 11A / 21A / 23A / 43A VFD007EL 21A / 23A / 43A VFD015EL 23A / 43A
<b>Frame B</b> 	115V: 0.75 kW 230V: 1.5 kW~3.7 kW 460V: 2.2 kW~3.7 kW	VFD007EL11A VFD015EL 21A VFD022EL 21A / 23A / 43A VFD037EL 23A / 43A

## Industrial Automation Headquarters

### Delta Electronics, Inc.

Taoyuan Technology Center  
No.18, Xinglong Rd., Taoyuan District,  
Taoyuan City 33068, Taiwan  
TEL: 886-3-362-6301 / FAX: 886-3-371-6301

### Asia

#### Delta Electronics (Shanghai) Co., Ltd.

No.182 Minyu Rd., Pudong Shanghai, P.R.C.  
Post code : 201209  
TEL: 86-21-6872-3988 / FAX: 86-21-6872-3996  
Customer Service: 400-820-9595

#### Delta Electronics (Japan), Inc.

Tokyo Office  
Industrial Automation Sales Department  
2-1-14 Shibadaimon, Minato-ku  
Tokyo, Japan 105-0012  
TEL: 81-3-5733-1155 / FAX: 81-3-5733-1255

#### Delta Electronics (Korea), Inc.

Seoul Office  
1511, 219, Gasan Digital 1-Ro., Geumcheon-gu,  
Seoul, 08501 South Korea  
TEL: 82-2-515-5305 / FAX: 82-2-515-5302

#### Delta Energy Systems (Singapore) Pte Ltd.

4 Kaki Bukit Avenue 1, #05-04, Singapore 417939  
TEL: 65-6747-5155 / FAX: 65-6744-9228

#### Delta Electronics (India) Pvt. Ltd.

Plot No.43, Sector 35, HSIIDC Gurgaon,  
PIN 122001, Haryana, India  
TEL: 91-124-4874900 / FAX : 91-124-4874945

#### Delta Electronics (Thailand) PCL.

909 Soi 9, Moo 4, Bangpoo Industrial Estate (E.P.Z),  
Pattana 1 Rd., T.Phraksa, A.Muang,  
Samutprakarn 10280, Thailand  
TEL: 66-2709-2800 / FAX : 662-709-2827

#### Delta Electronics (Australia) Pty Ltd.

Unit 20-21/45 Normanby Rd., Notting Hill Vic 3168, Australia  
TEL: 61-3-9543-3720

## Americas

### Delta Electronics (Americas) Ltd.

Raleigh Office  
P.O. Box 12173, 5101 Davis Drive,  
Research Triangle Park, NC 27709, U.S.A.  
TEL: 1-919-767-3813 / FAX: 1-919-767-3969

### Delta Electronics Brazil

São Paulo Sales Office  
Rua Itapeva, 26 - 3º, andar Edifício Itapeva,  
One - Bela Vista 01332-000 - São Paulo - SP - Brazil  
TEL: 55-12-3932-2300 / FAX: 55-12-3932-237

### Delta Electronics International Mexico S.A. de C.V.

Mexico Office  
Gustavo Baz No. 309 Edificio E PB 103  
Colonia La Loma, CP 54060  
Tlalnepantla, Estado de México  
TEL: 52-55-3603-9200

## EMEA

### Headquarters: Delta Electronics (Netherlands) B.V.

Sales: Sales.IA.EMEA@deltaww.com  
Marketing: Marketing.IA.EMEA@deltaww.com  
Technical Support: iatechnicalsupport@deltaww.com  
Customer Support: Customer-Support@deltaww.com  
Service: Service.IA.emea@deltaww.com  
TEL: 31(0)40 800 3900

### BENELUX: Delta Electronics (Netherlands) B.V.

De Witbogt 20, 5652 AG Eindhoven, The Netherlands  
Mail: Sales.IA.Benelux@deltaww.com  
TEL: 31(0)40 800 3900

### DACH: Delta Electronics (Netherlands) B.V.

Coesterweg 45, D-59494 Soest, Germany  
Mail: Sales.IA.DACH@deltaww.com  
TEL: 49(0)2921 987 0

### France: Delta Electronics (France) S.A.

ZI du bois Challand 2, 15 rue des Pyrénées,  
Lisses, 91090 Evry Cedex, France  
Mail: Sales.IA.FR@deltaww.com  
TEL: 33(0)1 69 77 82 60

### Iberia: Delta Electronics Solutions (Spain) S.L.U

Ctra. De Villaverde a Vallecas, 265 1º Dcha Ed.  
Hormigueras – P.I. de Vallecas 28031 Madrid  
TEL: 34(0)91 223 74 20

Carrer Llacuna 166, 08018 Barcelona, Spain

Mail: Sales.IA.Iberia@deltaww.com

### Italy: Delta Electronics (Italy) S.r.l.

Via Meda 2-22060 Novedrate(CO)  
Piazza Grazioli 18 00186 Roma Italy  
Mail: Sales.IA.Italy@deltaww.com  
TEL: 39 039 8900365

### Russia: Delta Energy System LLC

Vereyskaya Plaza II, office 112 Vereyskaya str.  
17 121357 Moscow Russia  
Mail: Sales.IA.RU@deltaww.com  
TEL: 7 495 644 3240

### Turkey: Delta Greentech Elektronik San. Ltd. Sti. (Turkey)

Şerifaii Mah. Hendem Cad. Kule Sok. No:16-A  
34775 Ümraniye – İstanbul  
Mail: Sales.IA.Turkey@deltaww.com  
TEL: 90 216 499 9910

### GCC: Delta Energy Systems AG (Dubai BR)

P.O. Box 185668, Gate 7, 3rd Floor, Hamarain Centre  
Dubai, United Arab Emirates  
Mail: Sales.IA.MEA@deltaww.com  
TEL: 971(0)4 2690148

### Egypt + North Africa: Delta Electronics

Unit 318, 3rd Floor, Trivium Business Complex, North 90 street,  
New Cairo, Cairo, Egypt  
Mail: Sales.IA.MEA@deltaww.com