



Automation for a Changing World

Delta Power Meter DPM Series



www.deltaww.com



Delta Power Meter DPM Series

The DPM Series precisely measures various electrical energy and power quality parameters, including power factors, harmonics, and current/voltage unbalance. This series also features a variety of communication protocols for easy integration with critical power systems and monitoring functions to provide power data, off-limit alarms, and history logs.

¡Visítanos! www.ceitsa.com

Panel Mount Type DPM-C Series



- Real-time data display and easy integration with remote monitoring systems, suitable for general applications in machine rooms

Applications

Distribution board | Electrical room |
Factory/Building energy management system

DIN Rail Mount Type DPM-D Series



- Easy installation and integration for equipment energy management

Applications

High power consuming equipment |
Electrical equipment cabinet | Enclosure

Multi-Loop Type DPM-M Series



- Multiple and selective large-scale circuit monitoring with lots of power circuits to save cost

Applications

Shopping mall | Dormitory | Telecommunication System

High Precision Power Measurement

- Precise measurement of bidirectional electrical energy and power parameters, meeting IEC 62053-22 standards

Built-in Protocols for Easy Integration

- Built-in RS-485 communication port supports Modbus for transmission of all measurement values to the PLCs, PCs and monitoring software

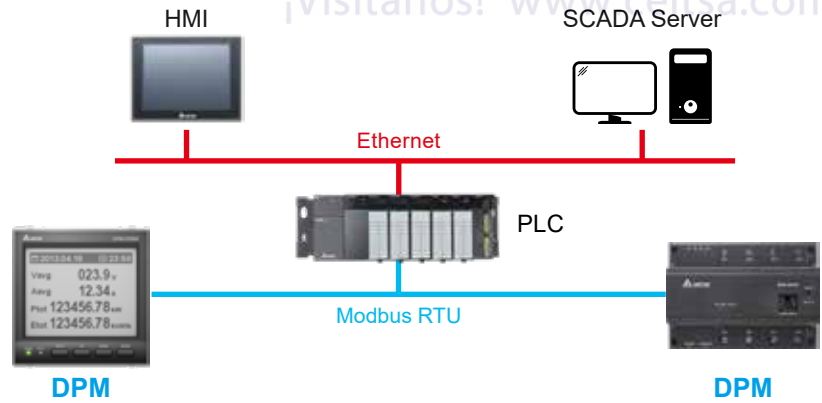

PC-based Configuration Software

- The power meter configuration software DPMSOft collects electricity data and sets up meters via Modbus communication, achieving easy power management and analysis

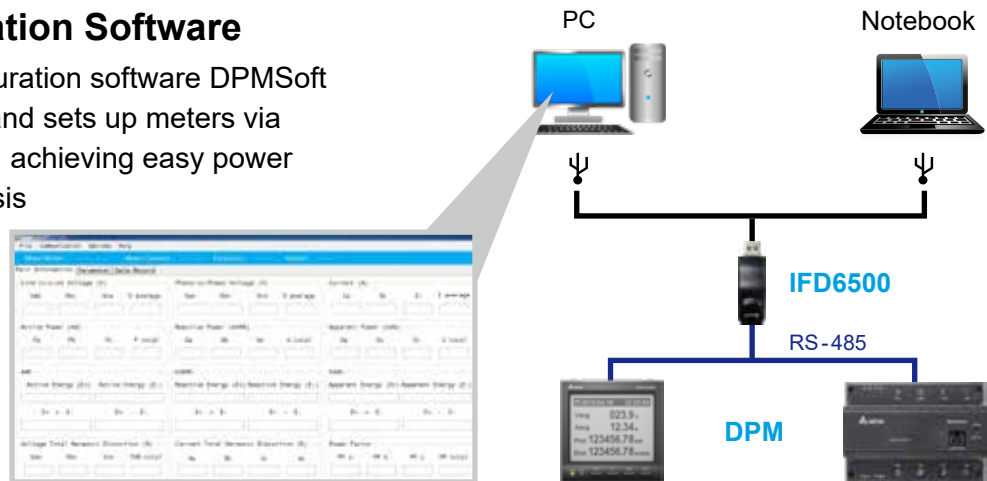

User-defined Parameter Groups

- Allows user-defined Modbus addresses to multiple corresponding parameters for the host computer to acquire data at one time and enhance efficiency

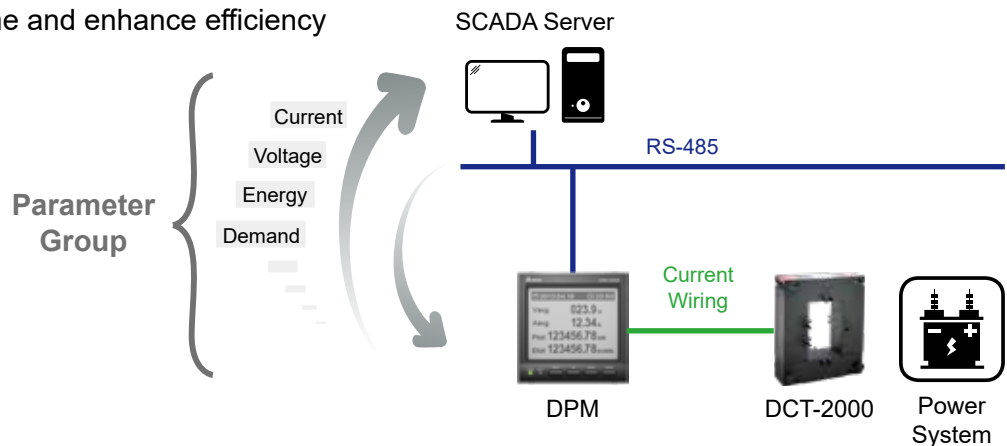

Panel Mount Type DPM-C Series

- Suitable for applications in general power systems
- Large LCD displays power data in real time
- A variety of communication protocols for easy integration
- Various power monitoring functions for different applications

Applications
Distribution board | Electrical room |
Factory/Building energy management system



Features

Multi-Language Display

- Large dot matrix LCD (198x168 dots), high font recognition
- Multi-language display: English (capital and small letters), Chinese, Japanese and other languages



DPM-C530: dot matrix LCD for high recognition display, better than segment LCD display

Ptot 123456.78 kW
Etot 123456.78 kVARh



Event Alarms and History Logs

- Keeps max. 2 months of electricity measurement values for analysis;
up to 17 power parameters selectable for recordings of different time intervals (e.g. recording 17 electricity parameters every 5 minutes for up to 2 months);
29 types of built-in alarms and up to 500 alarms recording

Interval	0~59 secs.	1~5 mins.	5~60 mins.
Capacity			
Max. Data Types	6	17	17
Max. Storage Time (Days)	7	31	62

Auto-Recording

- Automatic calculation of monthly energy consumption
- Allows users to setup specific dates for monthly calculation

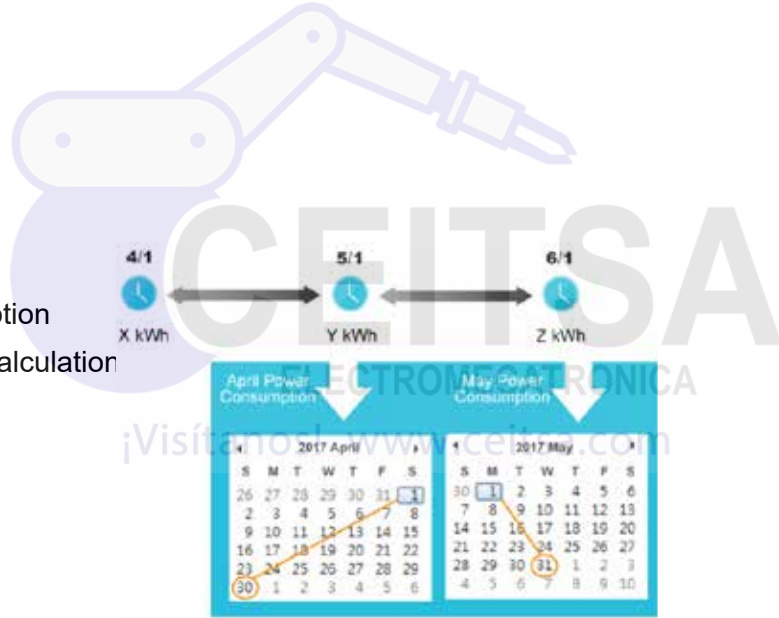

Multi-Tariff

- Automatic measurement & calculation of power consumption during a specific time period
- Multiple interval groups setting to measure power consumption at different periods of time

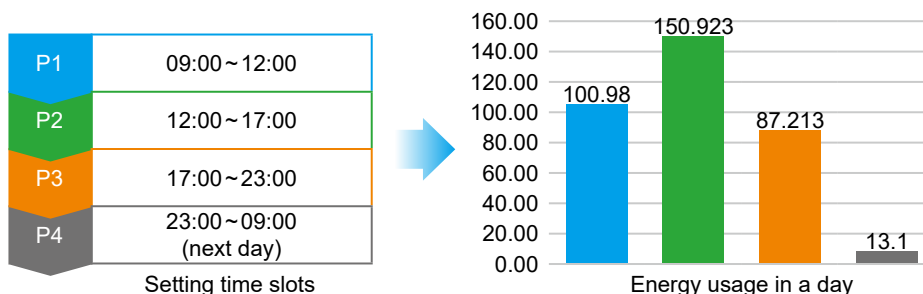

Ethernet Communication

- Dual Ethernet protocols support Modbus TCP
- Easy serial connection without gateway, no need to occupy communication ports
- Basic settings and data viewing on web page

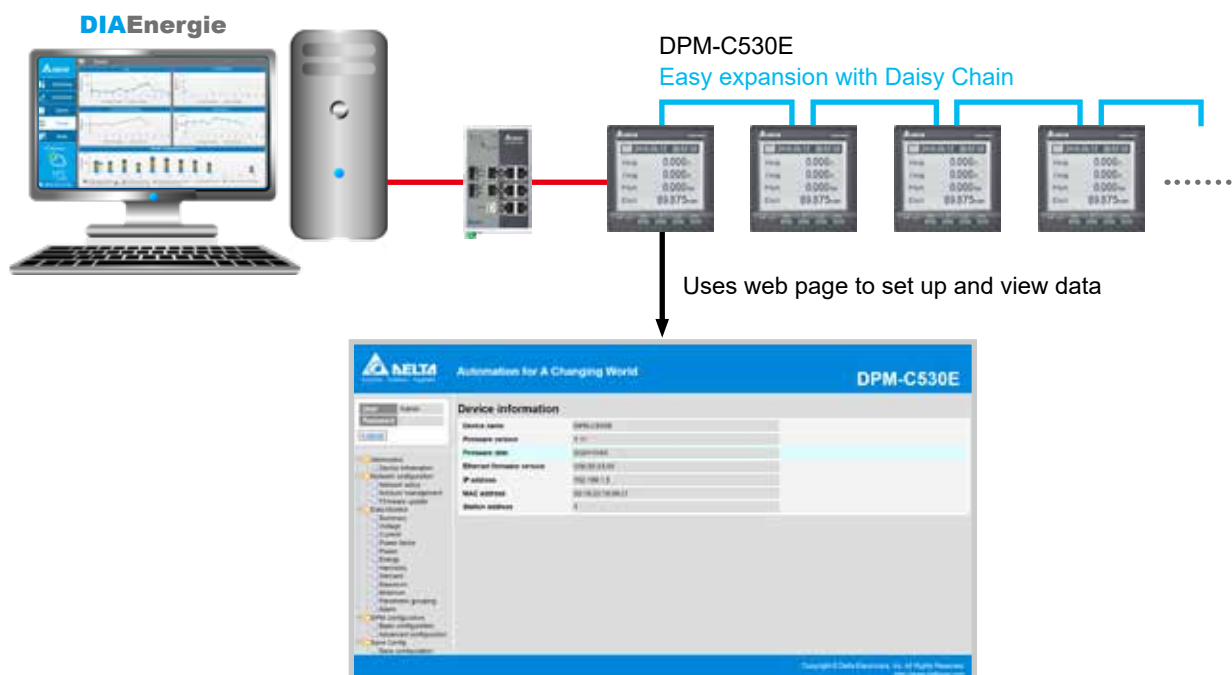

WiFi

- WiFi transmission
 - Reduced wiring cost and time
 - High-speed data exchange and data transmission capability (faster than RS-485)
 - Highly secure wireless data exchange
- No wiring limit, reduces cost and manpower for wiring

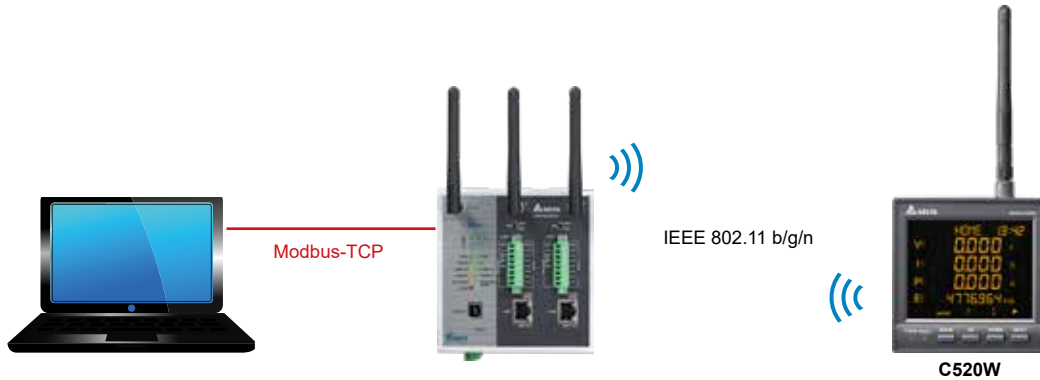

DI/DO Digital Input and Output Functions

- Adopts built-in power source to input alert signals with dry contact and save wiring cost; the optoelectronic isolation functions ensure cable safety
- Offers normal open (NO) relay and dry contact (2A/30V_{DC} or 2A/250V_{AC}) for output broadly applied in alert control output

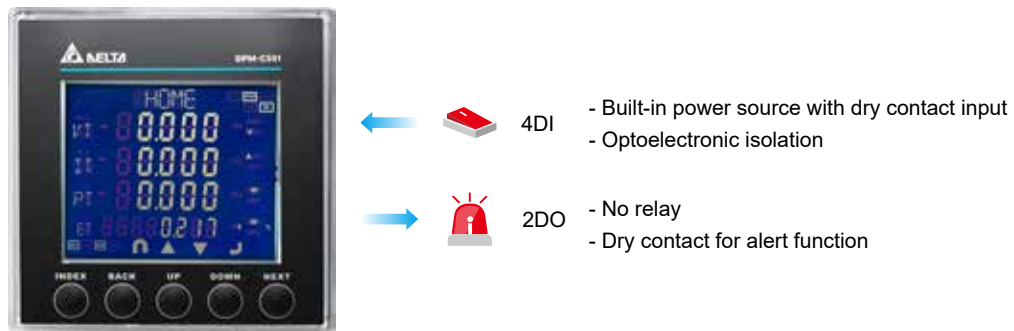



DMP-C Series Information

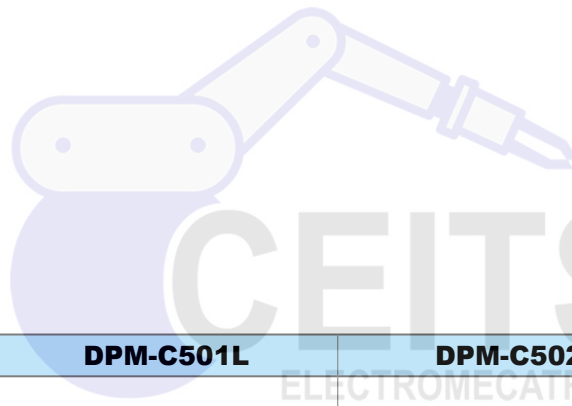

Model	DPM-C530	DPM-C530E	DPM-C520	DPM-C520W
Product Appearance				
Front Panel Dimensions	96x96 mm	96x96 mm	96x96 mm	96x96 mm
Accuracy Class				
Active Energy (IEC 62053-22)	Class 0.5S	Class 0.5S	Class 0.5S	Class 0.5S
Instantaneous Measurement				
Current	●	●	●	●
Voltage	●	●	●	●
Frequency	●	●	●	●
Active, Reactive and Apparent Power	●	●	●	●
Power Factor	●	●	●	●
Active, Reactive and Apparent Energy	●	●	●	●
Demand Value				
Current	●	●		
Power	●	●		
Calculation Mode	Fixed Block	Sliding Block/Fixed Block		
Power Quality Analysis				
Current/Voltage Unbalance	●	●	●	●
Total Harmonic Distortion (Current/Voltage)	●	●	●	●
Individual Current/Voltage Harmonics	31 st	31 st		
Advanced Function				
Max./Min. Instantaneous Values with Timestamp	●	●	●	●
Alarm Function	●	●	●	●
Alarm Condition	29	29	10	10
Alarm Logs	●	●		
Data Logs	●	●		
User-defined Modbus Address	35	35	5	5
Monthly Energy Usage	●	●		
Multi-Tariff (Section number)	8	8		
Multi-Language UI	Chinese/English/Japanese	Chinese/English/Japanese		
I/O				
Digital Input				
Relay				
Communication				
RS-485	●		●	●
Ethernet		● (2 ports)		
Modbus	RTU/ASCII	TCP	RTU	RTU/TCP
BACnet MS/TP	●			
WiFi (802.11 b/g/n)				●



Model	DPM-C320	DPM-C501L	DPM-C502
Product Appearance			
Front Panel Dimensions	72x72 mm	96x96 mm	96x96 mm
Accuracy Class			
Active Energy (IEC 62053-22)	Class 0.5S	0.5%	0.5%
Instantaneous Measurement			
Current	●	●	●
Voltage	●	●	●
Frequency	●	●	●
Active, Reactive and Apparent Power	●	●	●
Power Factor	●	●	●
Active, Reactive and Apparent Energy	●	●	●
Demand Value			
Current			
Power			●
Calculation Mode			Sliding Block
Power Quality Analysis			
Current/Voltage Unbalance	●	●	●
Total Harmonic Distortion (Current/Voltage)	●	●	●
Individual Current / Voltage Harmonics			31 st
Advanced Function			
Max./Min. Instantaneous Values with Timestamp	●	●	●
Alarm Function	●	●	●
Alarm Condition	10	10	10
Alarm Logs			
Data Logs			●
User-defined Modbus Address	5	5	5
Monthly Energy Usage			
Multi-Tariff (Section number)			4
Multi-Language UI			
I/O			
Digital Input		4	4
Relay		2	2
Communication			
RS-485	●	●	●
Modbus	RTU	RTU	RTU

Technical Specifications

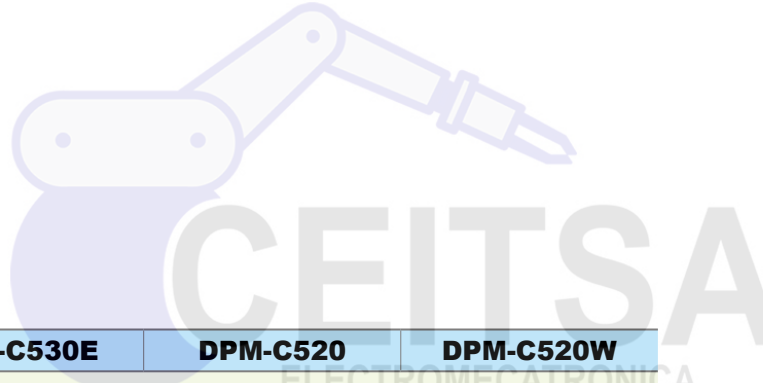

Model	DPM-C530	DPM-C530E	DPM-C520	DPM-C520W
Measurement Accuracy				
Current	± 0.5%	± 0.5%	± 0.5%	± 0.5%
Voltage	± 0.5%	± 0.5%	± 0.5%	± 0.5%
Active Energy	IEC 62053-22 Class 0.5S			
Reactive Energy	± 1%	± 1%	± 1%	± 1%
Apparent Energy	± 2%	± 2%	± 2%	± 2%
Active Power	± 0.5%	± 0.5%	± 0.5%	± 0.5%
Reactive Power	± 1%	± 1%	± 1%	± 1%
Apparent Power	± 2%	± 2%	± 2%	± 2%
Power Factor	± 0.5%	± 0.5%	± 0.5%	± 0.5%
Frequency	± 0.5%	± 0.5%	± 0.5%	± 0.5%
Input				
Measuring System Type	1P2W, 1P3W, 3P3W, 3P4W			
Voltage	35 V _{AC} ~ 690 V _{AC} (L-L) 20 V _{AC} ~ 400 V _{AC} (L-N)			
Current	1A/5A			
Frequency	45 ~ 70Hz			
Control Power	AC: 100 ~ 240V (max. power consumption 4.6W) DC: 100 ~ 300V			
Data Record				
Max./Min. Value	●	●	●	●
Alarm Status & Timestamp	●	●	●	●
Alarm Counting	●	●	●	●
Alarm Logs	500	500		
Data Logs	Up to 17 parameters with configurable interval & duration (e.g. 17 parameters for 30 days at 1 minute intervals)	Up to 17 parameters with configurable interval & duration (e.g. 17 parameters for 30 days at 1 minute intervals)		
Customizable Data Logs	●	●		
Communication				
Protocol (Interface)	Modbus RTU/ASCII (RS-485) BACnet MS/TP (RS-485)	Modbus TCP (Ethernet)	Modbus RTU (RS-485)	Modbus RTU (RS-485) / Modbus TCP (WiFi, IEEE802.11 b/g/n)
Mechanical Design				
IP Rating - Front Panel	IP52			
IP Rating - Case	IP20			
Dimensions (W x H x D, mm)	96 x 96 x 95.4	96 x 96 x 127.5	96 x 96 x 95.4	96 x 96 x 95.4
Operating Environment				
Operating Temperature	-20 °C ~ +60 °C			
Storage Temperature	-30 °C ~ +70 °C			
Relative Humidity	~ 95% RH			
Altitude	Below 2,000 meters			
Electromagnetic Compatibility				
Electrostatic Discharge	IEC 61000-4-2			
Immunity to Radiated Fields	IEC 61000-4-3			
Immunity to Fast Transients	IEC 61000-4-4			
Immunity to Impulse Waves	IEC 61000-4-5			
Conducted Immunity	IEC 61000-4-6			
Immunity to Magnetic Fields	IEC 61000-4-8			
Immunity to Voltage Dips	IEC 61000-4-11			
Radiated Emissions	FCC Part 15, EN 55011 Class A			
Conducted Emissions	FCC Part 15, EN 55011 Class A			
Harmonics Emissions	IEC 61000-3-2			
Flicker Emissions	IEC 61000-3-3			
Certification				
Safety	UL/CE/RCM	UL/CE		
Accuracy	IEC 62053-22/CMA			
WiFi				CE/FCC/JRF/KCC/NCC/NTC/IC

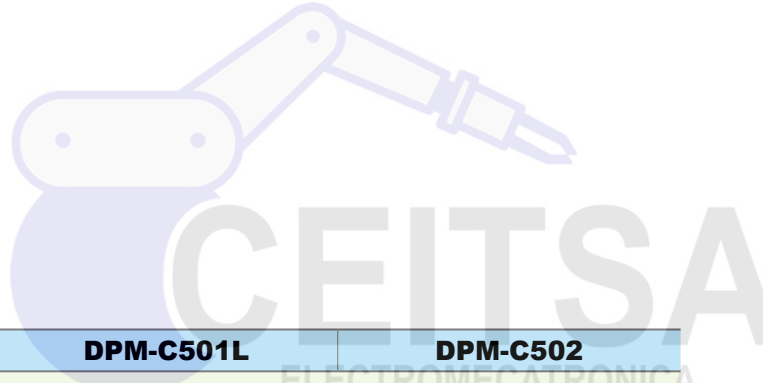

Model	DPM-C320	DPM-C501L	DPM-C502
Measurement Accuracy			
Current	± 0.5%	± 0.5%	± 0.5%
Voltage	± 0.5%	± 0.5%	± 0.5%
Active Energy	IEC 62053-22 Class 0.5S	± 0.5%	± 0.5%
Reactive Energy	± 1%	± 1%	± 1%
Apparent Energy	± 2%	± 2%	± 2%
Active Power	± 0.5%	± 0.5%	± 0.5%
Reactive Power	± 1%	± 1%	± 1%
Apparent Power	± 2%	± 2%	± 2%
Power Factor	± 0.5%	± 0.5%	± 0.5%
Frequency	± 0.5%	± 0.5%	± 0.5%
Input			
Measuring System Type	1P2W, 1P3W, 3P3W, 3P4W		
Voltage	35 V _{AC} ~690 V _{AC} (L-L) 20 V _{AC} ~400 V _{AC} (L-N)		
Current	1A/5A		
Frequency	45~70Hz		
Control Power	AC: 100~240V (max. power consumption 4.6W) DC: 100~300V		
Data Record			
Max. /Min. Value	●	●	●
Alarm Status & Timestamp	●	●	●
Alarm Counting	●	●	●
Alarm Logs			
Data Logs			Fixed 4 parameters with configurable interval & duration (e.g. 4 parameters for 7 days at 1 minute intervals)
Customizable Data Logs			
Communication			
Protocol (Interface)	Modbus RTU (RS-485)	Modbus RTU (RS-485)	Modbus RTU (RS-485)
Mechanical Design			
IP Rating - Front Panel	IP52		
IP Rating - Case	IP20		
Dimensions (WxHxD, mm)	72x72x107.7	96x96x95.4	
Operating Environment			
Operating Temperature	-20 °C~+60 °C	-20 °C~+50 °C	
Storage Temperature	-30 °C~+70 °C	-30 °C~+60 °C	
Relative Humidity	~ 95% RH		
Altitude	Below 2,000 meters		
Electromagnetic Compatibility			
Electrostatic Discharge	IEC 61000-4-2		
Immunity to Radiated Fields	IEC 61000-4-3		
Immunity to Fast Transients	IEC 61000-4-4		
Immunity to Impulse Waves	IEC 61000-4-5		
Conducted Immunity	IEC 61000-4-6		
Immunity to Magnetic Fields	IEC 61000-4-8		
Immunity to Voltage Dips	IEC 61000-4-11		
Radiated Emissions	FCC Part 15, EN 55011 Class A		
Conducted Emissions	FCC Part 15, EN 55011 Class A		
Harmonics Emissions	IEC 61000-3-2		
Flicker Emissions	IEC 61000-3-3		
Certification			
Safety	UL/CE		
Accuracy	IEC 62053-22/CMA		CMA

Dimensions

DPM-C530
DPM-C520
DPM-C520W

DPM-C530E

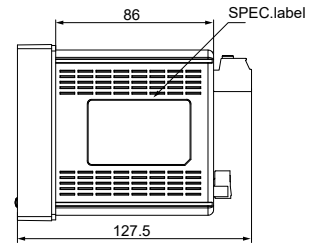
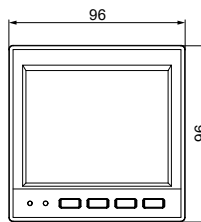
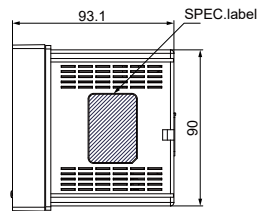
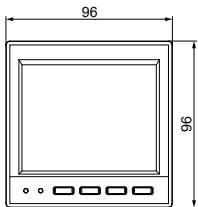
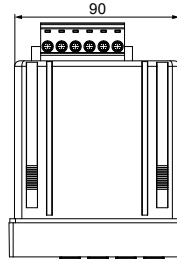
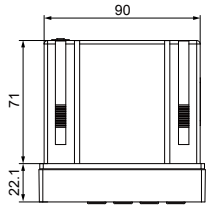

DPM-C501L
DPM-C502

DPM-C320

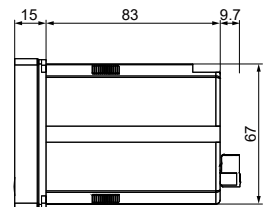
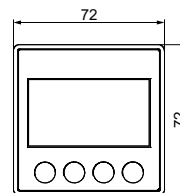
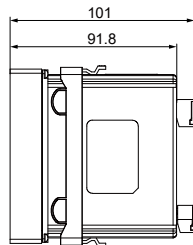
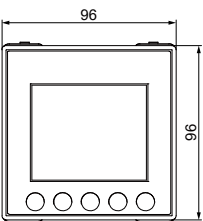
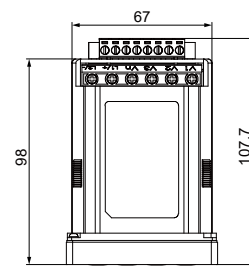
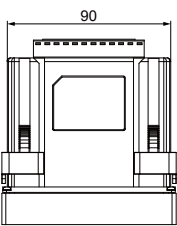

DIN Rail Mount Type DPM-D Series

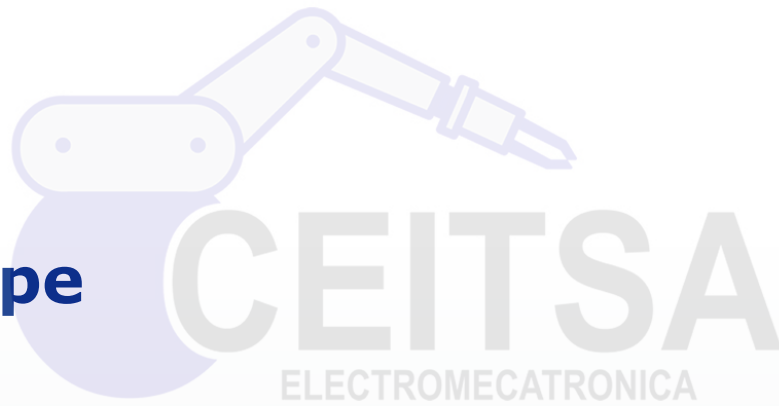

¡Visítanos! www.ceitsa.com

- Easy installation and integration for various equipment
- Applicable to general energy management systems
- Multiple energy measurement functions for different applications

Applications

High power consuming equipment |
Electrical equipment cabinet | Enclosure



Features

Multi-Tariff

- Automatic measurement & calculation of power consumption during a specific time period
- Multiple interval groups setting to measure power consumption at different periods of time

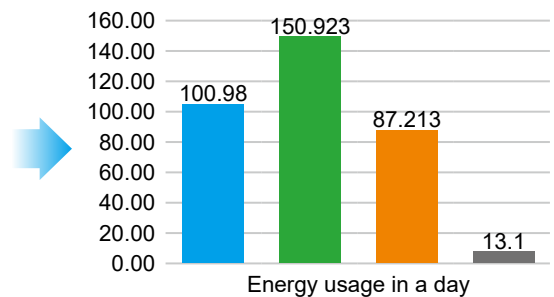
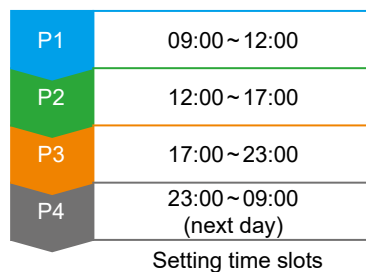

Pulse Output

- DPM-DA510/D530: Pulse output by active energy/reactive energy (import/export)
- Frequency divider: 1 ~ 9,999
- Pulse width: 0 ~ 5,000 ms (0 = 50% duty cycle)

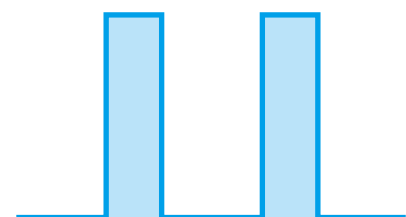

Pulse output 40 V_{DC}/50 mA
Per 0.1 kWh (default)

Data Recording

- User-defined time intervals for recording (Units: day/hour/min./sec.)
- Max. 50 parameters recording
- Max. 16 alarm conditions and max. 16 alarms recording

Recorded items vs. Record duration (at 1 minute intervals)

Parameter(s)	Recording Days
1	90
7	30
20	12

Demand Calculation

- Defines time intervals (default: 15 mins.)
- Demand calculation methods: Sliding block/fixed block
- Calculates the max. demand value/time in each tariff period

Sliding Block

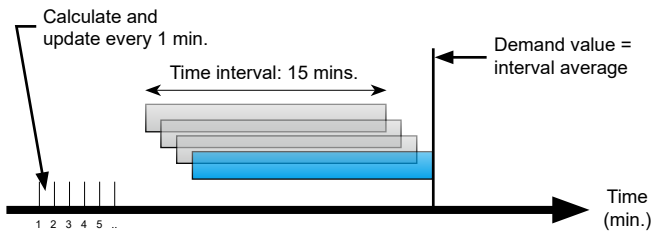

Fixed Block

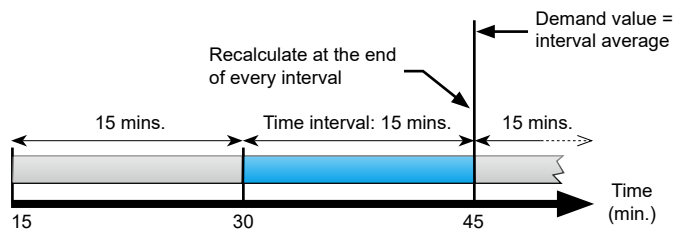

Automatic Wiring Correction (DPM-DA530)

- Automatic wiring correction via algorithm to save manpower for on-site re-wiring
- Fixes phase wiring errors and adjusts power flow direction

* Refer to product manual for function restrictions

Operation Process

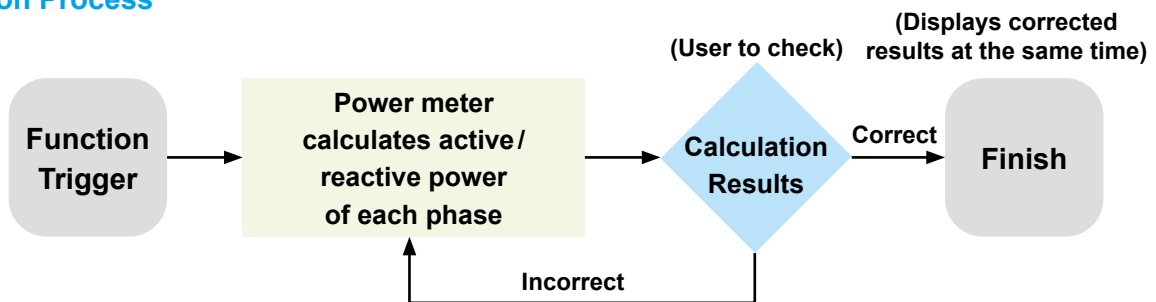

DPM-D Series Information

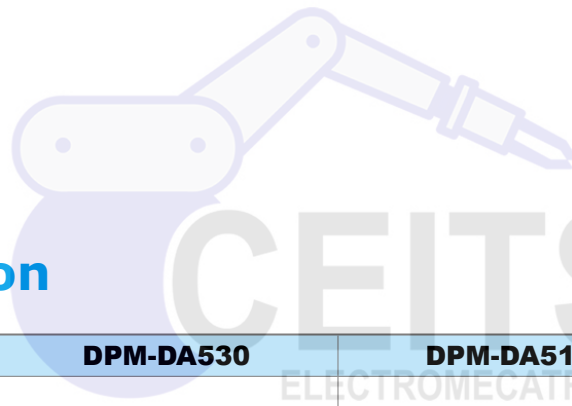

Model	DPM-D520I	DPM-DA530	DPM-DA510
Product Appearance			
Accuracy Class			
Active Energy (IEC 62053-22)	0.5%	0.5%	0.5%
Instantaneous Measurement			
Current	●	●	●
Voltage	●	●	●
Frequency	●	●	●
Active, Reactive and Apparent Power	●	●	●
Power Factor	●	●	●
Active, Reactive and Apparent Energy	●	●	●
Phasor Diagram (Current/Voltage)		●	●
Demand Value			
Current	●	●	
Power	●	●	
Calculation Mode	Fixed Block	Sliding Block/Fixed Block	
Power Quality Analysis			
Current/Voltage Unbalance	●	●	
Total Harmonic Distortion (Current/Voltage)	●	●	
Individual Current/Voltage Harmonics	31 st		
Advanced Function			
Max./Min. Instantaneous Values with Timestamp	●	●	
Alarm Function	●	●	
Alarm Condition	29	16	
Alarm Logs	●	●	
Data Logs	●	●	
User-defined Modbus Address	35	20	
Monthly Energy Usage	●		
Multi-Tariff (Section number)	8	8	
Auto Wiring Correction		●	
CO ₂ Emission		●	
I/O			
Pulse Output		1	1
Communication			
RS-485	●	●	●
Modbus	RTU/ASCII	RTU	RTU

Technical Specifications

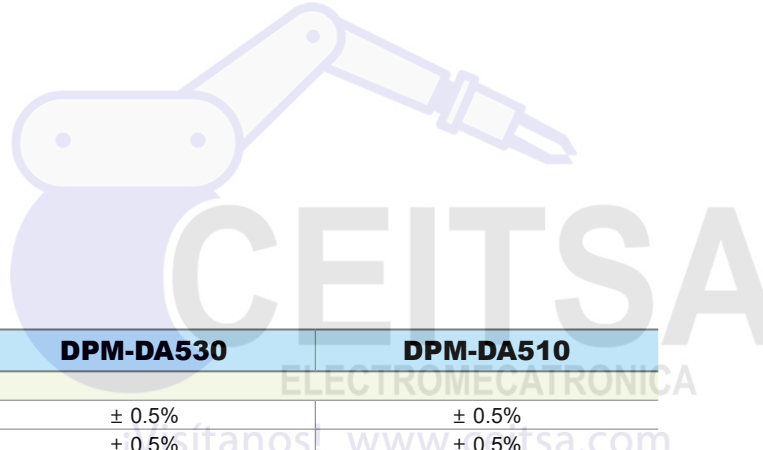

Model	DPM-D520I	DPM-DA530	DPM-DA510
Measurement Accuracy			
Current	± 0.5%	± 0.5%	± 0.5%
Voltage	± 0.5%	± 0.5%	± 0.5%
Active Energy	± 0.5%	± 0.5%	± 0.5%
Reactive Energy	± 1%	± 2%	± 2%
Apparent Energy	± 2%	± 2%	± 2%
Active Power	± 0.5%	± 0.5%	± 0.5%
Reactive Power	± 1%	± 2%	± 2%
Apparent Power	± 2%	± 2%	± 2%
Power Factor	± 0.5%	± 0.5%	± 0.5%
Frequency	± 0.5%	± 0.5%	± 0.5%
Input			
Measuring System Type	1P2W, 1P3W, 3P3W, 3P4W		
Voltage	35 V _{AC} ~690 V _{AC} (L-L) 20 V _{AC} ~400 V _{AC} (L-N)	35 V _{AC} ~600 V _{AC} (L-L) 20 V _{AC} ~350 V _{AC} (L-N)	
Current	63A	1A/5A	
Frequency	45~70 Hz	45~65 Hz	
Control Power	AC: 80~265 V (Max. Power Consumption 4.6 W) DC: 100~300V	AC: 100~240 V (Max. Power Consumption 3W) DC: 100~250V	
Data Record			
Max./Min. Value	●	●	
Alarm Status & Timestamp	●	●	
Alarm Counting	●	●	
Alarm Logs	500	16	
Data Logs	Up to 17 parameters with configurable interval & duration (e.g. 17 parameters for 30 days at 1 minute intervals)	Up to 50 parameters with configurable interval & duration (e.g. 7 parameters for 30 days at 1 minute intervals)	
Customizable Data Logs	●	●	
Communication			
Protocol (Interface)	Modbus RTU/ASCII (RS-485)	Modbus RTU (RS-485)	Modbus RTU (RS-485)
Mechanical Design			
IP Rating - Case	IP20	IP20	
Dimensions (WxHxD, mm)	126x90x67.4	72x87.5x58.7	
Operating Environment			
Operating Temperature	-20°C~+60°C	0°C~+60°C	
Storage Temperature	-30°C~+70°C	-10°C~+70°C	
Relative Humidity	~95% RH		
Altitude	Below 2,000 meters		
Electromagnetic Compatibility			
Electrostatic Discharge	IEC 61000-4-2		
Immunity to Radiated Fields	IEC 61000-4-3		
Immunity to Fast Transients	IEC 61000-4-4		
Immunity to Impulse Waves	IEC 61000-4-5		
Conducted Immunity	IEC 61000-4-6		
Immunity to Magnetic Fields	IEC 61000-4-8		
Immunity to Voltage Dips	IEC 61000-4-11		
Radiated Emissions	FCC Part 15, EN 55011 Class A		
Conducted Emissions	FCC Part 15, EN 55011 Class A		
Harmonics Emissions	IEC 61000-3-2		
Flicker Emissions	IEC 61000-3-3		
Certification			
Safety	CE/RCM	CE	
Accuracy	CMA		

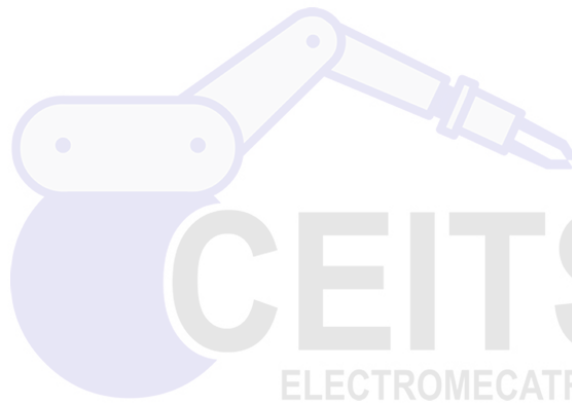

¡Visítanos! www.ceitsa.com

Dimensions

DPM-DA530
DPM-DA510

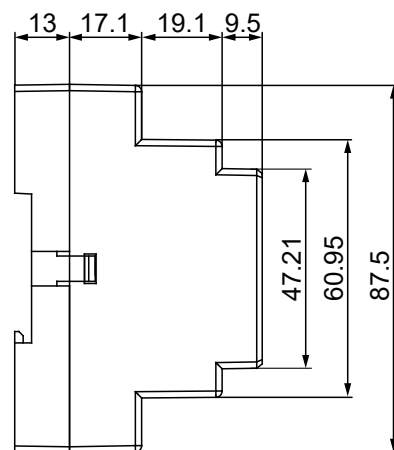
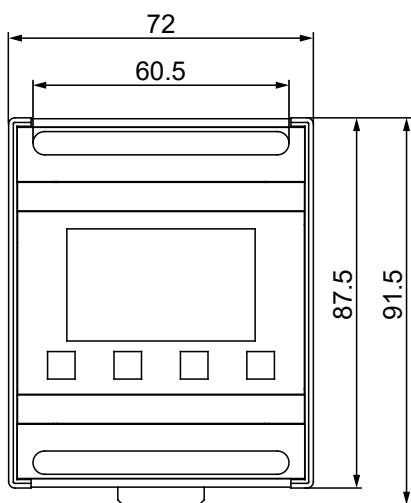
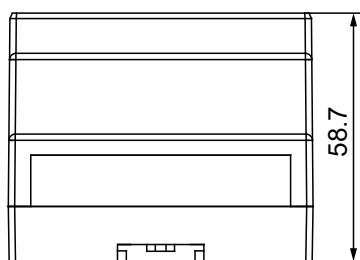

DPM-D520I

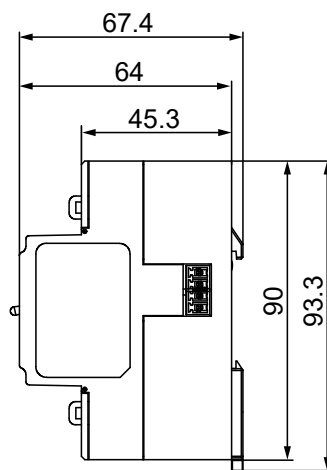
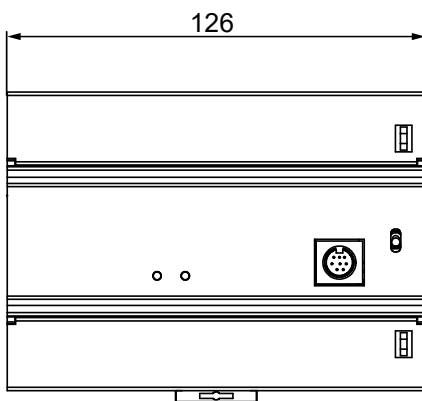

Multi-loop Type DPM-M Series

- Multiple and selective circuit monitoring reduces the use of power meters in large-scale areas
- Suitable for applications with lots of power circuits to save cost
- AC/DC measurement

¡Visítanos! www.ceitsa.com



Applications

Shopping mall | Dormitory | Telecommunication System

Features

Scalable Multi-Loop Configuration (DPM-MA3222)

- Dual main circuits with isolation for connection to different power systems
- Each main circuit connects 4 subcircuits; configures a total of 8 circuits (three-phase) or 24 circuits (single-phase)
- Subcircuit can be set to three-phase, single-phase, or three-phase & single-phase modes

Multi-loop
AC Power Meter
DPM-MA3222

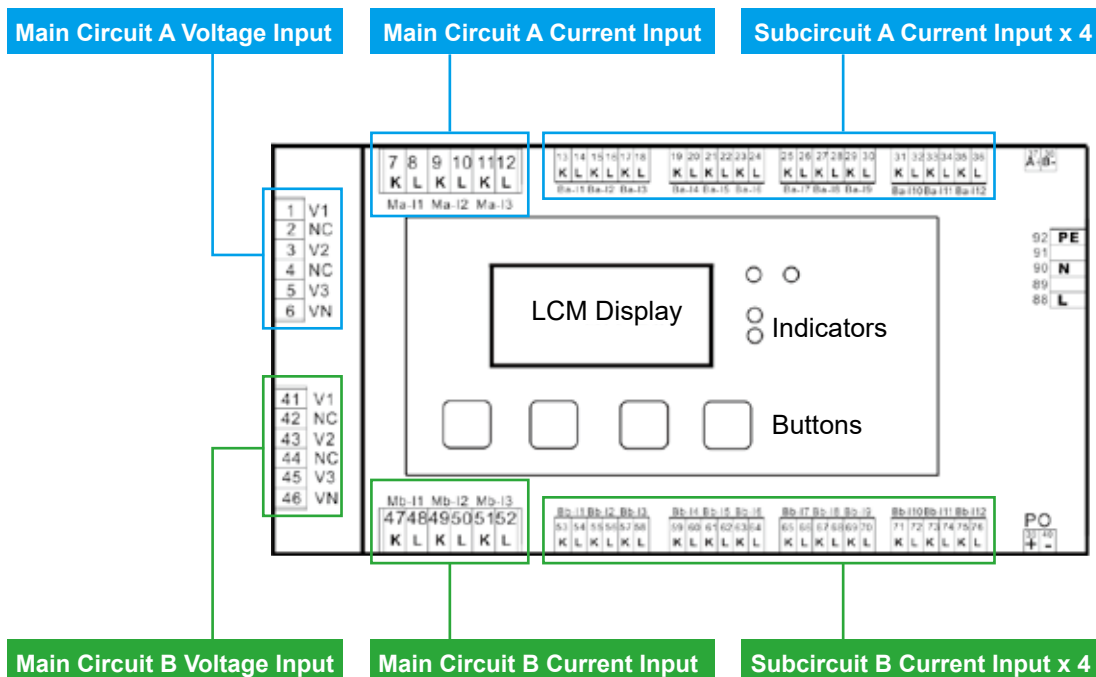

I/O Configuration (DPM-MA3222)

- Various I/O types for control and integration with peripheral devices



I/O Type	Qty.	Functions
Relay Output (RO)	4	<ul style="list-style-type: none"> • 5A/250 V_{AC}, 5A/30 V_{DC} • Alarm linkage: Hi/Lo/Hi hold/Lo hold
Digital Input (DI)	2	<ul style="list-style-type: none"> • Demand calculation trigger/stop • Record clearing: demand, max. demand, energy, max./min. value • Relay homing
Pulse Output (PO)	1	<ul style="list-style-type: none"> • 30 V_{DC}, 30 mA • Active/Reactive power output of any circuit

Multi-Loop DC Measurement (DPM-MA1121)

- Supports max. 5 DC circuits
- Suitable for telecommunication, green energy, energy storage applications
- Dedicated power supply for Hall sensor (optional)

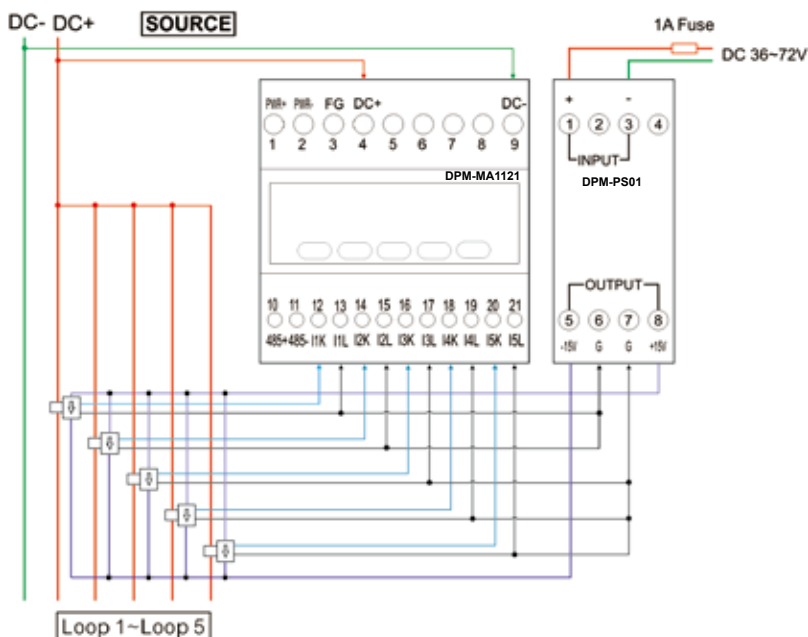

Multi-loop DC Power Meter DPM-MA1121



Hall Current Transformer (CT) Power Supply DPM-PS01



- Input voltage: 36~72V_{DC}
- Output voltage: ±15V_{DC}
- Output current: ±100mA

DPM-M Series Information



Model	DPM-MA3222	DPM-MA1121
Product Appearance		
Accuracy Class		
Active Energy	0.5%	0.5%
Circuit Qty.		
3-Phase Measurement	8	
Single-Phase Measurement	24	5
Instantaneous Measurement		
Current	●	●
Voltage	●	●
Frequency	●	
Active power	●	●
Reactive and Apparent Power	●	
Power Factor	●	
Active Energy	●	●
Reactive and Apparent Energy	●	
Demand Value		
Current	●	
Power	●	
Calculation Mode	Sliding Block/Fixed Block	
Power Quality Analysis		
Current/Voltage Unbalance	●	
Total Harmonic Distortion (Current/Voltage)	●	
Individual Current/Voltage Harmonics	31 st	
Advanced Function		
Max./Min. Instantaneous Values with Timestamp	●	
Alarm Function	●	
Alarm Condition	48	
Data Logs	●	●
User-defined Modbus Address	80	20
I/O		
Digital Input	2	
Relay	4	
Pulse Output	1	
Communication		
RS-485	●	●
Modbus	RTU	RTU

Technical Specifications

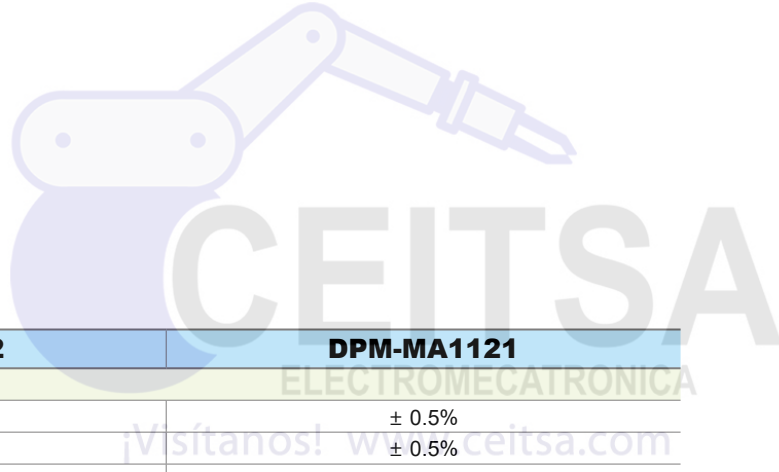

Model	DPM-MA3222	DPM-MA1121
Measurement Accuracy		
Current	± 0.5%	± 0.5%
Voltage	± 0.5%	± 0.5%
Active Energy	± 0.5%	± 0.5%
Reactive Energy	± 2%	N/A
Apparent Energy	± 2%	N/A
Active Power	± 0.5%	± 0.5%
Reactive Power	± 2%	N/A
Apparent Power	± 2%	N/A
Power Factor	± 0.5%	N/A
Frequency	± 0.5%	N/A
Input		
Measuring System Type	1P2W, 1P3W, 3P3W, 3P4W	1P2W
Voltage	35 V _{AC} ~ 600 V _{AC} (L-L) 20 V _{AC} ~ 400 V _{AC} (L-N)	≤ 100 V _{DC}
Current	Main: 5A Subcircuit: 333 mV	± 4 V _{DC} (Hall CT)
Frequency	45 ~ 65 Hz	
Control Power	AC: 100 ~ 240V (max. power consumption 15W) DC: 100 ~ 250V	DC: 20 ~ 56V (max. power consumption 4W)
Data Record		
Max. / Min. Value	●	
Data Logs	Up to 86 parameters with configurable interval & duration (e.g. 40 parameters for 7 days at 1 minute Intervals)	Up to 21 parameters with configurable interval & duration (e.g. 20 parameters for 6 days at 1 minute Intervals)
Customizable Data Logs	●	●
Communication		
Protocol (Interface)	Modbus RTU (RS-485)	Modbus RTU (RS-485)
Mechanical Design		
IP Rating - Case	IP20	
Dimensions (WxHxD, mm)	199x118x77	54x81x65.5
Operating Environment		
Operating Temperature	0°C ~ +60°C	
Storage Temperature	-10°C ~ +70°C	
Relative Humidity	~ 95% RH	
Altitude	Below 2,000 meters	
Electromagnetic Compatibility		
Electrostatic Discharge	IEC 61000-4-2	
Immunity to Radiated Fields	IEC 61000-4-3	
Immunity to Fast Transients	IEC 61000-4-4	
Immunity to Impulse Waves	IEC 61000-4-5	
Conducted Immunity	IEC 61000-4-6	
Immunity to Magnetic Fields	IEC 61000-4-8	
Immunity to Voltage Dips	IEC 61000-4-11	
Radiated Emissions	FCC Part 15, EN 55011 Class A	
Conducted Emissions	FCC Part 15, EN 55011 Class A	
Harmonics Emissions	IEC 61000-3-2	
Flicker Emissions	IEC 61000-3-3	
Certification		
Safety	CE	

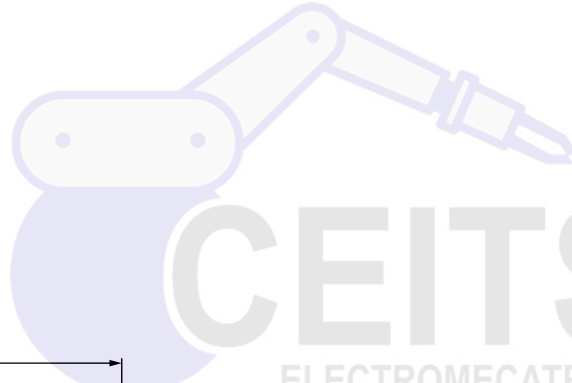

CEITSA

ELECTROMECA TRONICA

¡Visítanos! www.ceitsa.com

Dimensions

DPM-MA3222

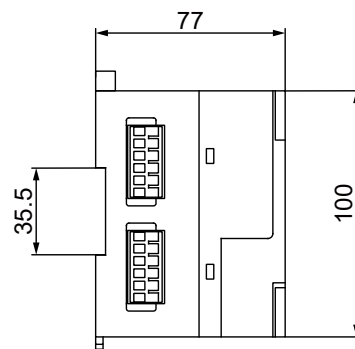
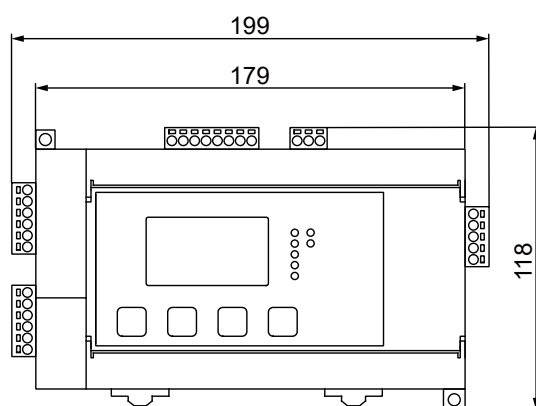
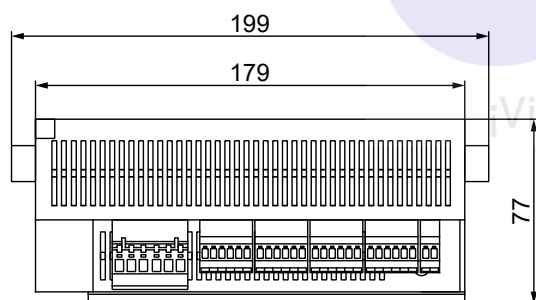

DPM-MA1121

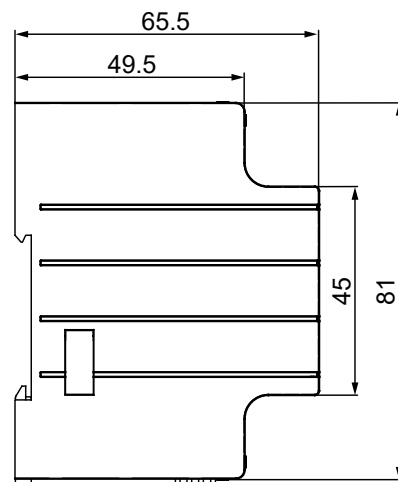
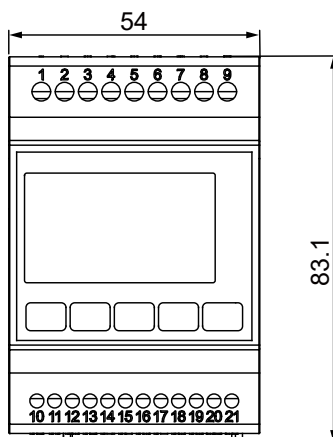
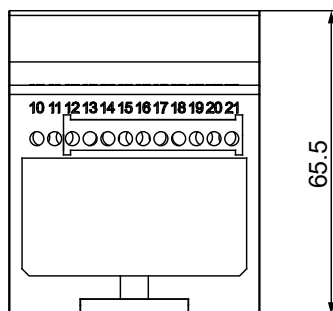



Current Transformer (CT)

- Accessories for current measurement, suitable for all types of power meters
- Proportionally transforms high circuit current into low current (or low voltage) signals for current measurement

Applications

Matches with all types of power meters to transform high current into measurable low current (voltage)

Product Information (Refer to Ordering Information for more details)

Type	Model	Features
Solid Core CT 	DCT-MC	<ul style="list-style-type: none"> • Installation through the CT core • Applicable to new system configuration
Compact Split Core CT 	DCT-CS	<ul style="list-style-type: none"> • Compact size, easy to install/dismantle by opening the split top • Suitable for various applications
	DCT-MV	
Split Core CT 	DCT-S	<ul style="list-style-type: none"> • Easy to install/dismantle by opening the split top • Complies with safety certifications

Ordering Information

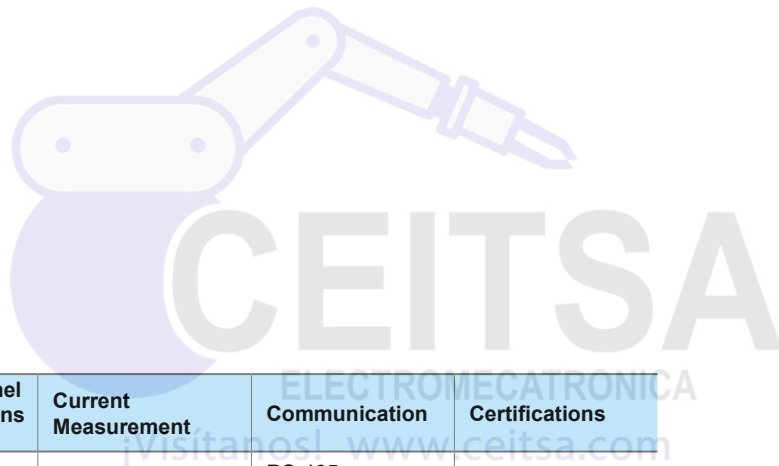

Panel Mount Type Power Meter

Model	Functions (Refer to Technical Specs. for details)	Front Panel Dimensions (mm)	Current Measurement	Communication	Certifications
DPM-C530	<ul style="list-style-type: none"> Electrical parameters measurement (Active energy accuracy Class 0.5S) Multi-tariff power measurement 	96 x 96	Through external CT (secondary side): 1A/5A	RS-485 (Modbus/BACNet MS/TP)	CE/UL/RCM
DPM-C530E	<ul style="list-style-type: none"> Demand value calculation Data recording Harmonics measurement 			Ethernetx2 (Modbus)	CE/UL
DPM-C502	<ul style="list-style-type: none"> Electrical parameters measurement (Active energy accuracy 0.5%) 4 DI/2 DO Other functions are similar to DPM-C530, refer to Technical Specs. for details 			RS-485 (Modbus)	
DPM-C520	<ul style="list-style-type: none"> Electrical parameters measurement (Active energy accuracy Class 0.5S) Harmonics measurement 	96 x 96		RS-485 (Modbus)	CE/UL
DPM-C520W				Wifi (802.11 b/g/n)	
DPM-C320		72 x 72		RS-485 (Modbus)	
DPM-C501L	<ul style="list-style-type: none"> Electrical parameters measurement (Active energy accuracy 0.5%) Harmonics measurement 4 DI/2 DO 	96 x 96		RS-485 (Modbus)	

DIN Rail Mount Type Power Meter

Model	Functions (Refer to Technical Specs. for details)	Current Measurement	Communication	Certifications
DPM-D520I	<ul style="list-style-type: none"> Electrical parameters measurement (Active energy accuracy 0.5%) Multi-tariff power measurement 	Direct measurement: 63A	RS-485 (Modbus)	CE
DPM-DA530	<ul style="list-style-type: none"> Demand value calculation Data recording Harmonics measurement Pulse output x 1 (DPM-DA530) 	Through external CT (secondary side): 1A/5A		
DPM-DA510	<ul style="list-style-type: none"> Electrical parameters measurement (Active energy accuracy 0.5%) Pulse output x 1 			

Multi-Loop Type Power Meter

Model	Functions (Refer to Technical Specs. for details)	Current Measurement	Communication	Certifications
DPM-MA3222	<ul style="list-style-type: none"> AC electrical parameters measurement (Active energy accuracy 0.5%) Circuit qty.: 8 (three-phase)/24 (single-phase) Data recording Harmonics measurement 2 DI/4 RO/1 PO 	Through external CT <ul style="list-style-type: none"> Main circuit: 5A (secondary side) Subcircuit: 333 mV (secondary side) 	RS-485 (Modbus)	CE
DPM-MA1121	<ul style="list-style-type: none"> DC electrical parameters measurement (Active energy accuracy 0.5%) Circuit qty.: 5 Data recording 	Through Hall Sensor		

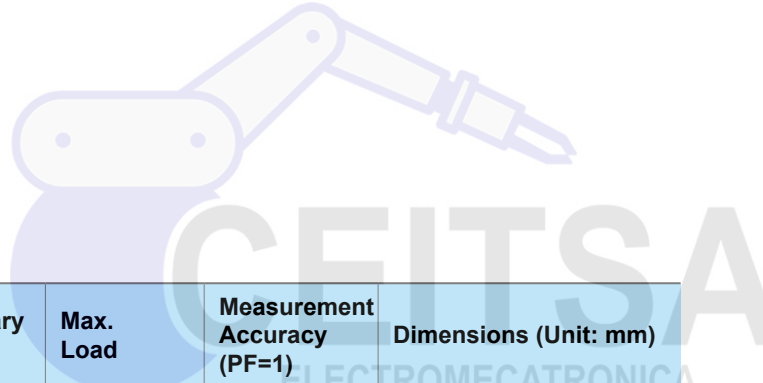

Solid Core CT

Model	Certification	Primary Current	Secondary Current	Max. Load	Measurement Accuracy (PF=1)	Dimensions (Unit: mm)
DCT-MC010-5	-	100A	5A	1.5 VA	1%	Outer: 80x60x38 Inner: 20x30.5
DCT-MC020-5	-	200A	5A	3.75 VA	0.5%	
DCT-MC030-5	-	300A	5A	5 VA	0.5%	Outer: 98x74.5x43 Inner: 42x42
DCT-MC040-5	-	400A	5A	7.5 VA	0.5%	
DCT-MC050-5	-	500A	5A	5 VA	0.5%	Outer: 127x103x45 Inner: 51x61
DCT-MC060-5	-	600A	5A	10 VA	0.5%	

Compact Split Core CT

Model	Certification	Primary Current	Secondary Current	Wiring Length	Measurement Accuracy (PF=1)	Dimensions (Unit: mm)
DCT-CS010-5	-	100A	5A	1,000 mm	1%	Outer: 66.8x49.8x34.2 Inner: 23.8x25.2
DCT-CS020-5	-	200A	5A	1,000 mm	1%	
DCT-CS030-5	-	300A	5A	1,000 mm	1%	
DCT-CS040-5	-	400A	5A	1,000 mm	1%	Outer: 85x69x42.5 Inner: 36.5x36.5
DCT-CS050-5	-	500A	5A	1,000 mm	1%	
DCT-CS060-5	-	600A	5A	1,000 mm	1%	
DCT-MV005-3	CE	5A	330 mV	1,200 mm	1%	Outer: 30.8x28.8x42.8 Inner: Φ 10.2
DCT-MV060-3	CE	60A		1,200 mm	0.5%	Outer: 30.3x33.9x49 Inner: Φ 16.1
DCT-MV100-3	CE	100A		1,200 mm	0.5%	Outer: 53.3x40.2x70 Inner: Φ 24.1
DCT-MV200-3	CE	200A		1,200 mm	0.5%	
DCT-MV300-3	CE	300A		1,200 mm	0.5%	Outer: 67x42.8x83 Inner: Φ 24.1
DCT-MV400-3	CE	400A		1,200 mm	0.5%	

Split Core CT

Model	Certification	Primary Current	Secondary Current	Max. Load	Measurement Accuracy (PF=1)	Dimensions (Unit: mm)
DCT-S201B	UL	100A	5A	1.0 VA	1.0%	Outer: 90 x 40 x 110 Inner: 30 x 20
DCT-S211B	UL	200A	5A	1.0 VA	0.5%	
DCT-S221B	UL	300A	5A	1.5 VA	0.5%	
DCT-S231B	UL	400A	5A	1.5 VA	0.5%	
DCT-S241B	UL	500A	5A	2.5 VA	0.5%	
DCT-S251B	UL	600A	5A	2.5 VA	0.5%	
DCT-S261B	UL	750A	5A	2.5 VA	0.5%	Outer: 115 x 37 x 159 Inner: 80 x 50
DCT-S2C1B	UL	800A	5A	3.75 VA	0.5%	
DCT-S271B	UL	1,000A	5A	5 VA	0.5%	
DCT-S301C	CE	100A	5A	1.5 VA	1.0%	
DCT-S211C	CE	200A	5A	1.0 VA	0.5%	Outer: 89 x 40 x 115 Inner: 32 x 21
DCT-S221C	CE	300A	5A	1.5 VA	0.5%	
DCT-S231C	CE	400A	5A	2.5 VA	0.5%	
DCT-S241C	CE	500A	5A	2.5 VA	0.5%	
DCT-S251C	CE	600A	5A	2.5 VA	0.5%	Outer: 116 x 51 x 145 Inner: 80 x 50
DCT-S261C	CE	750A	5A	2.5 VA	0.5%	
DCT-S271C	CE	1,000A	5A	5 VA	0.5%	
DCT-S281C	CE	1,500A	5A	7.5 VA	0.5%	Outer: 146 x 51.6 x 196 Inner: 80 x 122
DCT-S291C	CE	2,000A	5A	10 VA	0.5%	Outer: 186 x 67 x 250 Inner: 81 x 160.5
DCT-S2A1C	CE	2,500A	5A	15 VA	0.5%	
DCT-S2B1C	CE	3,000A	5A	20 VA	0.5%	

Hall Sensor Power Supply

Model	Input Voltage		Output		Ripple & Noise (mVp-p, Typ./Max.)	Efficiency (% , @ Full load)	Dimensions (mm)
	Normal (V _{DC} , Range)	Max. (V _{DC})	Voltage (V _{DC})	Current (mA, Max./Min.)			
DPM-PS01	48 (36~72)	80	±15	±100/±5	40/75	80	65.5 x 26 x 81



Global Operations

ASIA (Taiwan)



Taoyuan Technology Center (Green Building)



Taoyuan Plant 1



Tainan Plant (Diamond-rated Green Building)

ASIA (China)



Wujiang Plant 3



Shanghai Office



ASIA (Japan)



Tokyo Office

ASIA (India)



Rudrapur Plant
(Green Building)

EUROPE



Amsterdam, the Netherlands

AMERICA



Research Triangle Park, U.S.A.

▲ 6 Factories ■ 117 Branch Offices ● 13 R&D Centers ■ 915 Distributors

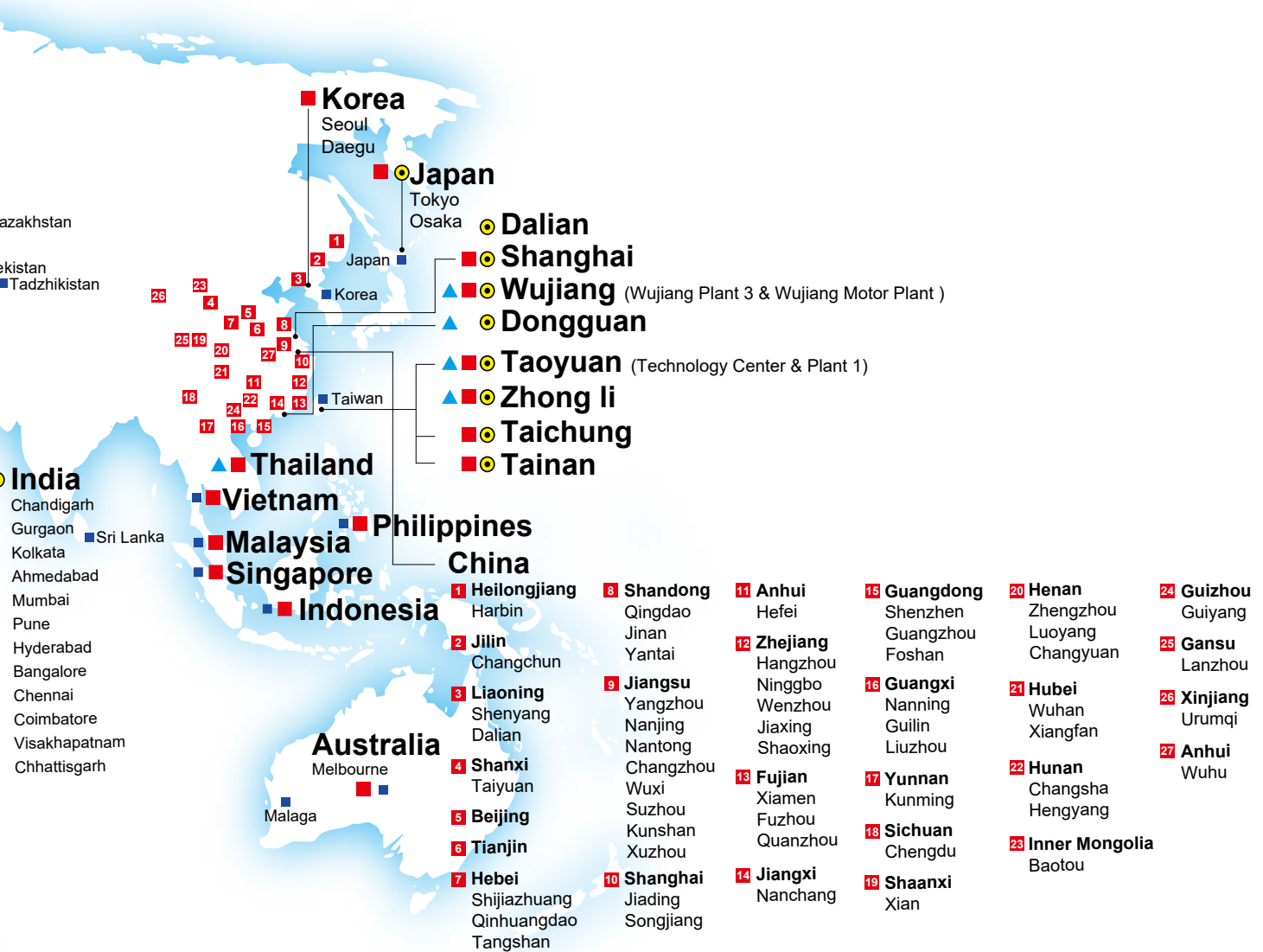



Smarter. Greener. Together.

Industrial Automation Headquarters

Delta Electronics, Inc.

Taoyuan Technology Center
No.18, Xinglong Rd., Taoyuan District,
Taoyuan City 33068, Taiwan
TEL: 886-3-362-6301 / FAX: 886-3-371-6301

Asia

Delta Electronics (Shanghai) Co., Ltd.

No.182 Minyu Rd., Pudong Shanghai, P.R.C.
Post code : 201209
TEL: 86-21-6872-3988 / FAX: 86-21-6872-3996
Customer Service: 400-820-9595

Delta Electronics (Japan), Inc.

Tokyo Office
Industrial Automation Sales Department
2-1-14 Shibadaimon, Minato-ku
Tokyo, Japan 105-0012
TEL: 81-3-5733-1155 / FAX: 81-3-5733-1255

Delta Electronics (Korea), Inc.

Seoul Office
1511, 219, Gasan Digital 1-Ro., Geumcheon-gu,
Seoul, 08501 South Korea
TEL: 82-2-515-5305 / FAX: 82-2-515-5302

Delta Energy Systems (Singapore) Pte Ltd.

4 Kaki Bukit Avenue 1, #05-04, Singapore 417939
TEL: 65-6747-5155 / FAX: 65-6744-9228

Delta Electronics (India) Pvt. Ltd.

Plot No.43, Sector 35, HSIIDC Gurgaon,
PIN 122001, Haryana, India
TEL: 91-124-4874900 / FAX : 91-124-4874945

Delta Electronics (Thailand) PCL.

909 Soi 9, Moo 4, Bangpoo Industrial Estate (E.P.Z),
Pattana 1 Rd., T.Phraksa, A.Muang,
Samutprakarn 10280, Thailand
TEL: 66-2709-2800 / FAX : 662-709-2827

Delta Electronics (Australia) Pty Ltd.

Unit 20-21/45 Normanby Rd., Notting Hill Vic 3168, Australia
TEL: 61-3-9543-3720

Americas

Delta Electronics (Americas) Ltd.

Raleigh Office
P.O. Box 12173, 5101 Davis Drive,
Research Triangle Park, NC 27709, U.S.A.
TEL: 1-919-767-3813 / FAX: 1-919-767-3969

Delta Electronics Brazil

São Paulo Sales Office
Rua Itapeva, 26 - 3º, andar Edifício Itapeva,
One - Bela Vista 01332-000 - São Paulo - SP - Brazil
TEL: 55-12-3932-2300 / FAX: 55-12-3932-237

Delta Electronics International Mexico S.A. de C.V.

Mexico Office
Gustavo Baz No. 309 Edificio E PB 103
Colonia La Loma, CP 54060
Tlalnepantla, Estado de México
TEL: 52-55-3603-9200



EMEA

Headquarters: Delta Electronics (Netherlands) B.V.

Sales: Sales.IA.EMEA@deltaww.com
Marketing: Marketing.IA.EMEA@deltaww.com
Technical Support: iatechnicalsupport@deltaww.com
Customer Support: Customer-Support@deltaww.com
Service: Service.IA.emea@deltaww.com
TEL: 31(0)40 800 3900

BENELUX: Delta Electronics (Netherlands) B.V.

De Witbogt 20, 5652 AG Eindhoven, The Netherlands
Mail: Sales.IA.Benelux@deltaww.com
TEL: 31(0)40 800 3900

DACH: Delta Electronics (Netherlands) B.V.

Coesterweg 45, D-59494 Soest, Germany
Mail: Sales.IA.DACH@deltaww.com
TEL: 49(0)2921 987 0

France: Delta Electronics (France) S.A.

ZI du bois Challand 2, 15 rue des Pyrénées,
Lisses, 91090 Evry Cedex, France
Mail: Sales.IA.FR@deltaww.com
TEL: 33(0)1 69 77 82 60

Iberia: Delta Electronics Solutions (Spain) S.L.U

Ctra. De Villaverde a Vallecas, 265 1º Dcha Ed.
Hormigueras – P.I. de Vallecas 28031 Madrid
TEL: 34(0)91 223 74 20

Carrer Llacuna 166, 08018 Barcelona, Spain

Mail: Sales.IA.Iberia@deltaww.com

Italy: Delta Electronics (Italy) S.r.l.

Via Meda 2-22060 Novedrate(CO)
Piazza Grazioli 18 00186 Roma Italy
Mail: Sales.IA.Italy@deltaww.com
TEL: 39 039 8900365

Russia: Delta Energy System LLC

Vereyskaya Plaza II, office 112 Vereyskaya str.
17 121357 Moscow Russia
Mail: Sales.IA.RU@deltaww.com
TEL: 7 495 644 3240

Turkey: Delta Greentech Elektronik San. Ltd. Sti. (Turkey)

Şerifaii Mah. Hendem Cad. Kule Sok. No:16-A
34775 Ümraniye – İstanbul
Mail: Sales.IA.Turkey@deltaww.com
TEL: 90 216 499 9910

GCC: Delta Energy Systems AG (Dubai BR)

P.O. Box 185668, Gate 7, 3rd Floor, Hamarain Centre
Dubai, United Arab Emirates
Mail: Sales.IA.MEA@deltaww.com
TEL: 971(0)4 2690148

Egypt + North Africa: Delta Electronics

Unit 318, 3rd Floor, Trivium Business Complex, North 90 street,
New Cairo, Cairo, Egypt
Mail: Sales.IA.MEA@deltaww.com